



PT5500i 5500W INVERTER GENERATOR



OPERATING INSTRUCTIONS

CONTENTS

SAFETY MESSAGES.....	4
1. SAFETY NOTICE.....	5
1. Safety Standard.....	5
2. Special Requirements.....	6
2.COMONENT IDENTIFICATION.....	7
1. Component Identification.....	7
2. Engine Type & Serial Number.....	8
3. CONTROLFUNCTION.....	9
1. Oil warning light (red).....	9
2. Overload indicator light (Red).....	9
4. PREPARATION.....	11
1. Fuel.....	11
2 Engine oil.....	11
3. Recoil Starter.....	12
4. Fuel Valve.....	12
5. AC Circuit Breaker/Over current Protector.....	12
6. Ground Terminal.....	13
5. GENERATOR OPERATION.....	14
1. Connection to the Household Power Supply.....	14
2. Generator Grounding.....	15
3. ACCurrent.....	15
4. DC Current.....	16
5. High Altitude Operation.....	16
6. STARTING THE ENGINE.....	17
1. Recoil Starter.....	17
2. Electric starting.....	17
7. STOPPING THE ENGINE.....	18
8. MAINTENANCE.....	18
1. Engine Oil Change.....	20
2. Air Cleaner Service.....	21
3. Fuel Sediment Cup Cleaning.....	22
4. Spark Plug Service.....	22
9. STORAGE.....	23
10. TROUBLESHOOTING.....	24
11. WIRING DIAGRAM.....	25
12. SPECIFICATIONS.....	26
13. WARRANTY	27

Introduction

Your new POWERTEC Generator will more than satisfy your expectations. It has been manufactured under stringent quality standards to meet superior performance criteria. You will find your new tool easy and safe to operate, and, with proper care, it will give you many years of dependable service.

Carefully read through this entire Instruction Manual before using your new POWERTEC Generator. Take special care to heed the cautions and warnings.

Your generator has many features that will make your job faster and easier. Safety, performance, and dependability have been given top priority in the development of this tool, making it easy to maintain and operate.

Environmental Protection

Recycle unwanted materials instead of disposing of them as waste. All tools, hoses and packaging should be sorted, taken to the local recycling centre and disposed of in an environmentally safe way.



Scope Of Product

This product is suited for home, camping and emergency power applications. It will operate most powertools, appliances and lighting.

Description Of Symbols

The rating plate on your tool may show symbols. These represent important information about the product or instructions on its use.



Wear hearing protection.
Wear eye protection.
Wear breathing protection.



Conforms to relevant standards for electromagnetic compatibility.

Specifications

Starting	Manual start/E-start (one-push start)
Running Watts	5000w
Peak Watts	5500w
AC voltage	230V
AC Frequency	50hz
Fuel Tank Capacity	15.5L
50% load working time	10hrs
Noise Level:	67dBA
Engine Displacement	312cc
Low Oil Shutdown	Yes
DC	Yes
Oil Capacity	0.85L
Economy Mode	Yes
Machine dimension (mm)	635x470x530
Package dimension (mm)	670x510x605
Net Weight	51kgs
Gross Weight	52kg

SAFETY MESSAGES

Your safety and the safety of others are very important. We have provided important safety messages in this manual and on the generator. Please read these messages carefully.

A safety message alerts you to potential hazards that could hurt you or others. Each safety message is preceded by a safety alert symbol and one of three words: DANGER, WARNING, or CAUTION. These mean:



You **WILL** be **KILLED** or **SERIOUSLY HURT** if you don't follow instructions.



You **CAN** be **KILLED** or **SERIOUSLY HURT** if you don't follow instructions.



You **CAN** be **HURT** if you don't follow instructions.



Your generator or other property could be damaged if you don't follow instructions.

1. SAFETY NOTICE

1. Safety Standard

Read and understand this owner's manual before operating your generator. You can help prevent accidents by being familiar with your generator's controls, and by observing safe operating procedures.

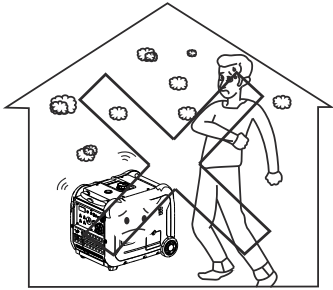
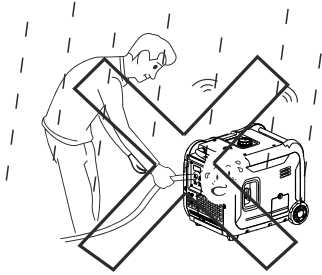
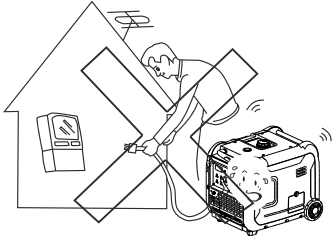
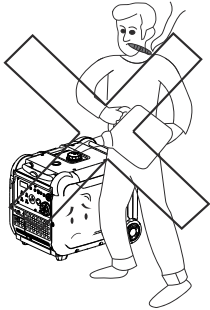
	
<p>Don't operate indoors.</p>	<p>Don't operate in wet conditions.</p>
	
<p>Don't directly connect to the household power supply</p>	<p>Don't smoke when refueling</p>

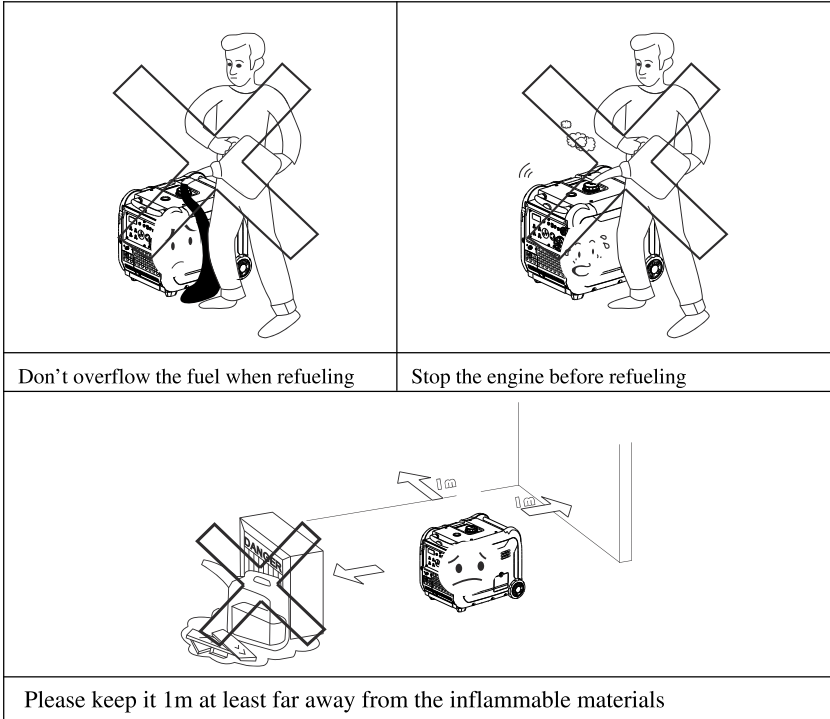

2. Special Requirements

Electrical equipment including lines and plug connections should be free from nudity.

The circuit breakers should be matched with the generator equipment.

If the circuit breakers require replacement, they must be replaced with a circuit breaker having identical ratings and performance characteristics.

Don't operate the generator before grounding.

If using extension lines, the requirement should be met as following: for 1.5mm² core, the line should not exceed 60m; for 2.5mm² core, the line should not exceed 100m.

2.COMPONENT IDENTIFICATION

1. Component Identification PT5500i

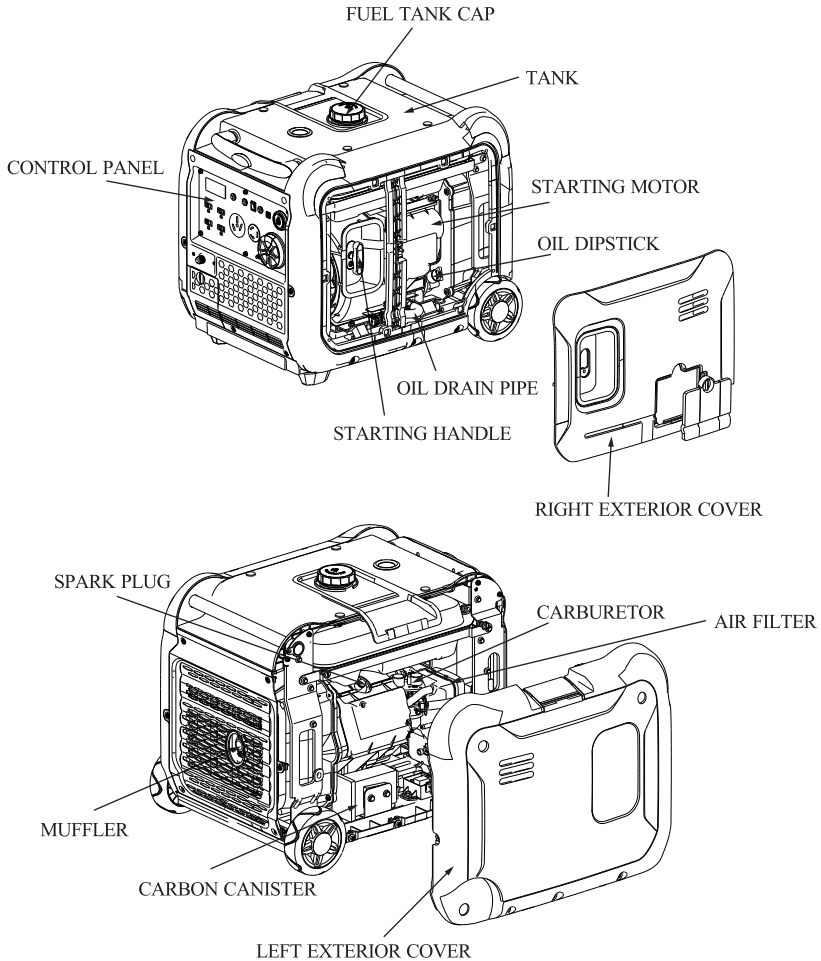

2. Engine Type & Serial Number

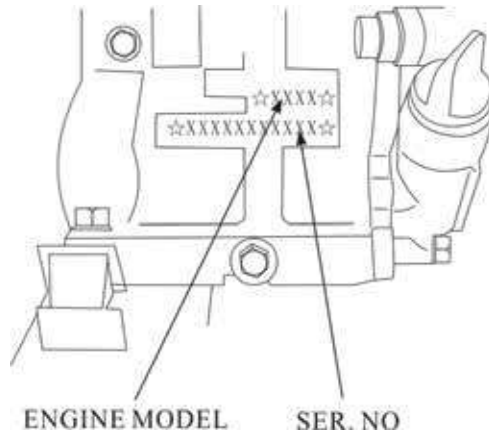

3. CONTROL FUNCTION

1. Low oil indicator

LED Lights up red when unit is low or out of oil. Engine will not run when indicator is lit.

When this light appears confirm engine is off, let the unit cool down, then add oil. Make sure to periodically check oil levels while filling to prevent overfilling.

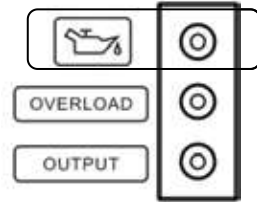

Tip: If the engine stalls or does not start, turn the engine switch to “ON” and then pull the recoil starter.

If the oil warning light flickers for a few seconds, the engine oil is insufficient.

Add oil and restart.

2. Overload indicator light (Red)

The overload indicator light comes on when an overload of a connected electrical device is detected, the inverter control unit overheats, or the AC output voltage rises. Then, the AC protector will trip, stopping power generation in order to protect the generator and any connected electric devices. The AC pilot light (Green) will go off and the overload indicator light (Red) will stay on, but the engine will not stop running.

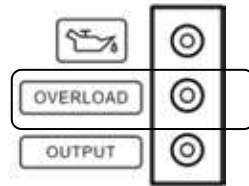

When the overload indicator light comes on and power generation stops, proceed as follows:

- 1) Turn off any connected electric devices and stop the engine.
- 2) Reduce the total wattage of connected electric devices within the rated output.
- 3) Check for blockages in the cooling air inlet and around the control unit.

If any blockages are found, remove.

- 4) After checking, restart the engine.

Tip: The overload indicator light may come on for a few seconds at first when using electric devices that require a large starting current, such as a compressor or a submersible pump. However, this is not a malfunction.

3. AC pilot light (Green)

The AC pilot light comes on when the engine starts and produces power.

4. Engine smart control (ECO)

① “ON”

When the ECO switch is turned to “ON”, the economy control unit controls the engine speed according to the connected load. The results are better fuel consumption and less noise.

② “OFF”

When the ECO switch is turned to “OFF”, the engine runs at the rated/min (3600r/min) regardless of whether or not it is connected a load.

Tip: The ECO must be turned to “OFF” when using electric devices that require a large starting current, such as a compressor or a submersible pump.

5. Ground (Earth) terminal

Ground (Earth) terminal connects the earth line for prevention of electric shock.

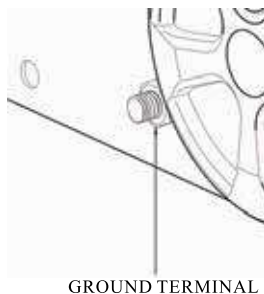
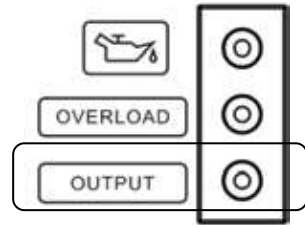

4. PREPARATION

1. Fuel

DANGER!

Fuel is highly flammable and poisonous. Check “SAFETY INFORMATION” carefully before filling.

Do not overfill the fuel tank, otherwise it may overflow when the fuel warms up and expands.

After filling the fuel, make sure the fuel tank cap is tightened securely.

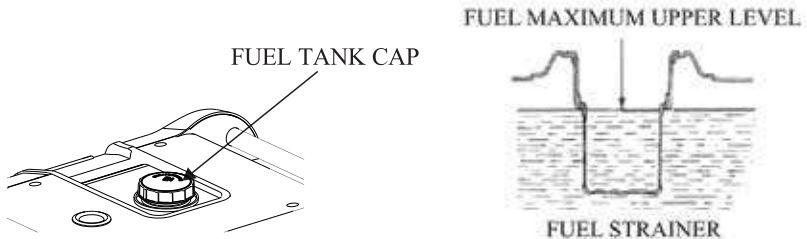

NOTICE

Immediately wipe off spilled fuel with a clean, dry, soft cloth, since fuel may deteriorate painted surfaces or plastic parts.

Use unleaded gasoline only, as leaded gasoline can severely damage internal parts of the generator.

Remove the fuel tank cap and fill the tank to the red level.

Recommended fuel: Unleaded gasoline

Fuel tank capacity:

PT5500i: 17L

2 Engine oil

The generator has been shipped without engine oil. Do not start the engine until it is filled with sufficient engine oil.

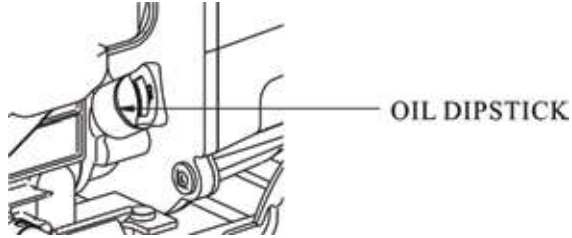

3. Recoil Starter

To start the engine, pull the starter grip lightly until resistance is felt, then pull briskly.

Do not allow the starter to snap back against the engine.

Return it gently to prevent damage to the starter.

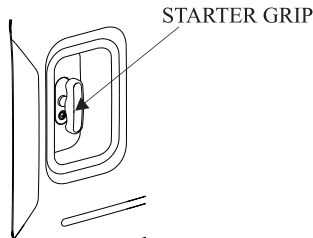

4. Fuel Valve

The fuel valve controls fuel flowing from the fuel tank to carburetor. Be sure to return the lever to “OFF” after stopping the engine.

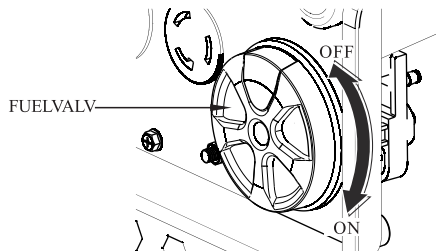

5. AC Circuit Breaker/Over current Protector

The overload current will automatically switch off circuit breaker to avoid short circuit of the load or overload. If the indicator of AC Over current

Protector is raised, the Over current Protector is now in the “OFF” position. Press the button of AC Overcurrent Protector to the “ON” position again a few minute later. If the circuit breaker is switched “OFF” automatically, switch the circuit breaker ON again.

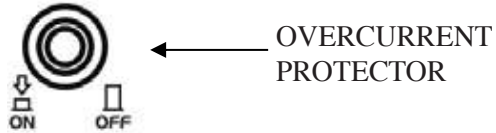

6. Ground Terminal

This ground terminal is specially used to connect the generator.



5. GENERATOR OPERATION

Generator operation environment:

- Temperature: $-5^{\circ}\text{C} \sim 40^{\circ}\text{C}$
- Humidity: Below 95%
- Height above sea level: 1000 m lower (If the area is 1000 m over, the power should be lowered in operation).

1. Connection to the Household Power Supply

NOTICE

When connecting the generator to the household power supply, connection must be made by a qualified electrician. After connecting, carefully check electric connection for their safety and reliability as improper electrical connection may cause generator damage, fire or injury.

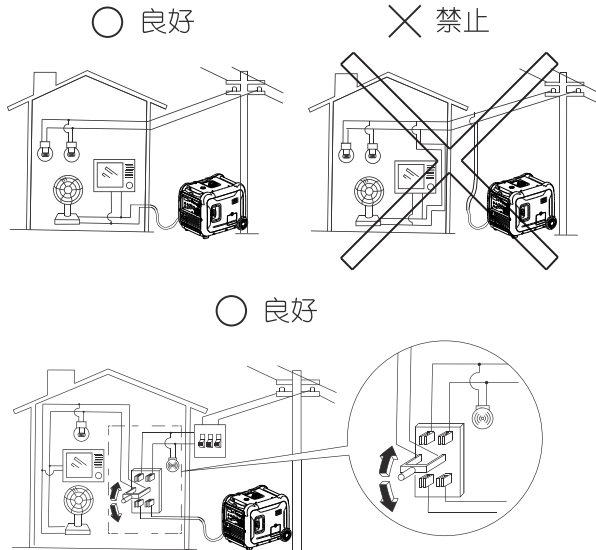

2. Generator Grounding

To prevent electrical shock or misuse from faulty appliances, the generator should be grounded with insulated lead.

3. AC Current

Before starting the generator, make sure that:

Total load appliance power (Total resistance, capacitive and inductive) does not exceed rated power of the generator.







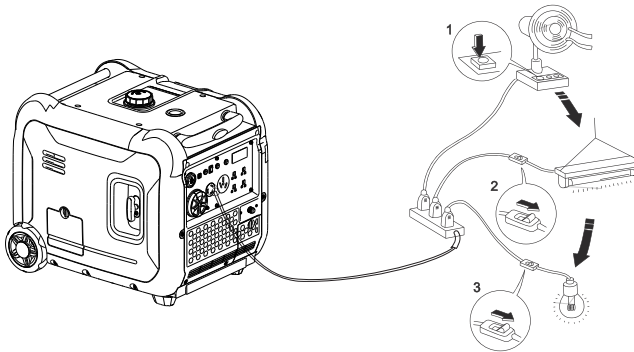

NOTICE

Overload operation will greatly shorten generator service life.

If the generator set is connected to multi-loads or electric appliances, please first connect to current maximum, in turn, current second, and final, current minimum.



In general, capacitive and inductive load, especially, motor-driven devices have a big starting current when starting. The following table is a reference for when connecting to the electric appliances.

Type	Wattage		Typical Device	Examples		
	Start	Rated		Device	Starting	Rated
Incandescent Lamp Heating Device	X1	X1	 Incandescent Lamp  Tv Set	 Incandescent Lamp 100W	100VA (W)	100VA (W)
Fluorescent Lamp	X2	X1.5	 Fluorescent Lamp	 Fluorescent Lamp 40W	80VA (W)	60VA (W)
Motor Drive Device	X3-5	X2	 Refrigerator  Electric Fan	 Refrigerator 150W	450-750VA (W)	300VA (W)

4. DC Current

DC Terminals

The DC terminals are used to provide power supply for DC lower power load and charge for other battery.

The terminals are colored red to identify the positive (+) terminal and black to identify the negative (-) terminal. Load connection method: The load must be connected to DC terminals with the proper polarity (load positive to positive of DC terminal and load negative to negative of DC terminal).

5. High Altitude Operation

At high altitude, the standard carburetor air-fuel mixture will be excessively rich. Output power will decrease, and fuel consumption will increase.

Engine performance can be improved by installing a smaller diameter main fuel jet in the carburetor and readjusting the pilot screw. If you always operate the engine at altitudes 1000 meters above sea level, you should have our company authorized dealer performed this carburetor modification. If not, you should lower load power in

operating generator.

Even equipped with suitable carburetor, engine horsepower will decrease approximately 3.5% for each 300 meter increase in altitude. The effect of altitude on horsepower will be lowered greater than this if no carburetor modification is made.

NOTICE

If a carburetor for high altitude is equipped with an engine suitable to a lower altitude, the lean air fuel mixture will cause the engine output power to be lower, over-heat and cause serious damage.

6. STARTING THE ENGINE

1. Recoil Starter

- (1) Remove all the loads out of the output.
- (2) Turn the fuel valve to the “ON” position.
- (3) Turn the AC circuit breaker to the “OFF” position.
- (4) Turn the choke lever to the “CLOSE” position.

NOTICE

Don't close the choke when starting the engine in warm state

- (5) Turn the generator switch to the “ON” position.
- (6) Pull the starter grip until compression is felt, then pull briskly.
- (7) Turn the choke lever to the “OPEN” position after the engine is warm.
- (8) Don't use electric apparatus before setting circuit breaker to the “ON” position.

2. Electric starting

- (1) Remove all the loads out of the output.
- (2) Turn the fuel valve to the “ON” position.

- (3) Turn the choke lever to the “CLOSE” position.

▲ WARNING

Don't close the choke when starting the engine in warm state.

- (4) Turn the generator switch to electric starting position.
- (5) After starting engine, immediately release generator switch and generator switch can automatically return to open position.
- (6) Turn the choke lever to “OPEN” position after the engine is warm.

NOTICE

Turn the gasoline switch to electric starting position for more than 5 seconds can damage the starting motor. If failing to start, release the switch and wait 10 seconds before operating it again.

If the speed of the starting motor drops fast after a period of time, it means that the battery should be recharged.

7. STOPPING THE ENGINE

- (1) Turn the AC circuit breaker to the “OFF” position.
- (2) Turn the generator switch to the “OFF” position.
- (3) Turn the fuel valve to the “OFF” position.

NOTICE

To stop the engine in an emergency, turn the generator switch to the “OFF” position.

8. MAINTENANCE

The engine must be properly maintained to ensure its operation will be safe, economical and trouble-free, as well as

eco-friendly.

In order to keep your gasoline engine in good working condition, it must be periodically serviced. The following maintenance schedule and routine inspection procedures must be carefully followed:

Items		Frequency	Each time	First 1 month or first 20hrs of operation	Thereafter, every 3 months or every 50hrs of operation	Every year or every 100 hrs of operation
Engine oil	Check- Refill		√			
	Replace			√	√	
Air filter element	Check		√			
	Clean			√		
	Replace				√	
Deposit Cup(if equipped)	Clean					√
Spark Plug	Check - adjust					√*
Spark arrester	Clean				√	
Idling (if equipped) **	Check - adjust					√
Valve clearance **	Check-adjust					√
Fuel tank & fuel filter **	Clean					√
Fuel line	Check	Every 2 years(change if necessary)				
Cylinder head, piston	Clean up carbon **	<225cc , Every 125hrs ≥225cc , Every 250hrs				
* These items should be replaced if replacement needed.						
** These items should be maintained and repaired by our authorized dealer, unless the owner has appropriate tools and is proficient with mechanical maintenance.						

NOTICE

- If the gasoline engine is frequently worked under high temperature or at a high load, change the oil every 25 hours.
- If the engine is frequently worked under dusty or other severe circumstances, clean the air filter element every 10 hours; If necessary, change the air filter element every 25 hours.
- The maintenance period and the exact time (hour), the one which comes first should govern.
- If you have missed the scheduled time to maintain your engine,

do it as soon as possible.

⚠ WARNING

Stop the engine before servicing. Put the engine on a level surface and remove the spark plug cap to prevent the engine from starting.

Never run your engine in a poorly ventilated room or other enclosed area, be sure to keep good ventilation in working area. The exhaust from the engine may contain poisonous CO, and inhalation can cause shock, unconsciousness and even death.

1. Engine Oil Change

Drain the oil while the engine is warm to assure complete and rapid draining.

1. Remove the oil dipstick and drain plug to drain the oil.
2. Reinstall the drain plug, then tighten the plug securely.
3. Refill oil and check the oil level.

Oil capacity: 5000i 0.8L

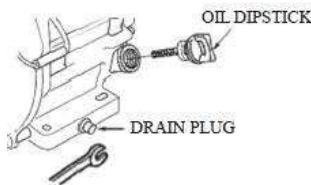
**⚠ CAUTION**

Used engine oil may cause skin cancer if repeatedly left in contact with the skin for prolonged periods. Although this is unlikely unless you handle used oil on a daily basis, it is still advisable to thoroughly wash your hands with soap and water

as soon as possible after handling used oil.

Please dispose of used engine oil in a manner that is compatible with the environment. We suggest you take it in a sealed container to your local service station or recycling center for reclamation. Do not throw it in the trash or pour it on the ground.

2. Air Cleaner Service

A dirty air cleaner will prevent air from flowing into the carburetor. To prevent carburetor malfunction, maintain the air cleaner regularly. Maintain more frequently when operating the generator in extremely dusty areas.

CAUTION

Using gasoline or flammable solvent to clean the filter element can cause a fire or explosion. Use only soapy water or nonflammable solvent.

NOTICE

Never run the generator without the air cleaner. If not, rapid engine wear will result.

(1) Open the air cleaner clip and open the air cover. Check the air cleaner element for complete and clean.

(2) If the air cleaner element is dirty, please clean the air cleaner element:

Wash the air cleaner element in a solution of household detergent and warm water, then rinse thoroughly or wash in nonflammable or high flash point solvent: Drop a few points engine oil in, then, squeeze out.

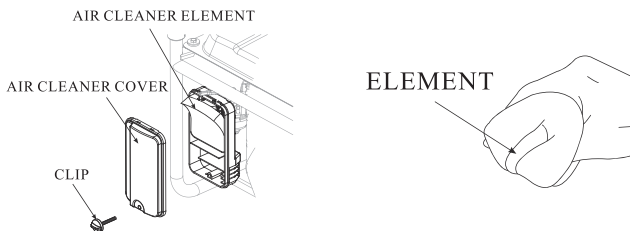

(3) Reinstall the air cleaner element and the cover.

3. Fuel Sediment Cup Cleaning

(1) Turn the fuel valve to the OFF position. Remove the sediment cup, O-ring and strainer according to the arrow direction.

(2) Clean the sediment cup, and O-ring, and strainer in nonflammable or high flash point solvent.

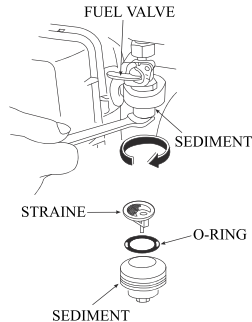

(3) Reinstall O-ring, and strainer and screw down the sediment cup.

(4) Turn the fuel valve ON and check for leaks.

4. Spark Plug Service

Recommended spark plugs: F7RTC or other equivalents

(1) Remove the spark plug cap.

(2) Use the plug wrench to remove the spark plug.

(3) Visually inspect the spark plug if the insulator is cracked, if cracked, replace with new the spark plug.

(4) Measure the plug gap with a feeler gauge. Correct as necessary by carefully bending the side electrode. The gap should be: 0.70-0.80 mm.

(5) Check the spark plug washer for good.

(6) Reinstall the spark plug, tighten it with plug wrench and impact the washer. Reinstall the spark plug accurately.

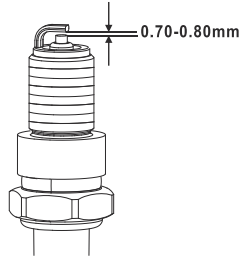
**NOTICE**

Please use the spark plug with suitable heat range.

9. STORAGE**WARNING**

In order to reduce risk of a hot engine or exhaust system causing burns or fires, let the engine cool before storing the generator. If storing the unit for an extended period, be sure the storage area is free of excessive humidity and dust.

(1) Drain the fuel in the fuel tank out, clean strainer, O-ring and sediment, then refit then well. Drain fuel out of the carburetor by loosening the drain bolt, then refit it and screw down the carburetor bolt.

WARNING

Gasoline is extremely flammable and is explosive under certain conditions. Drain fuel in a well-ventilated area with the engine stopped. Do not allow flames, smoke or sparks in the area during this procedure.

(2) Screw the oil dipstick off and screw the drain bolt off the crankcase to completely drain the oil out. Then screw down the drain bolt and fill fresh oil to upper mark, finally refit the oil dipstick well.

(3) Remove the spark plug, and pour about a tablespoon of clean engine oil into the cylinder. Crank the engine several revolutions to distribute the oil, then reinstall the spark plug.

(4) Slowly pull the starter grip until resistance is felt. Let the intake and exhaust valves in closing position.

(5) Place the generator in the clean area.

10. TROUBLESHOOTING

Engine not to start:

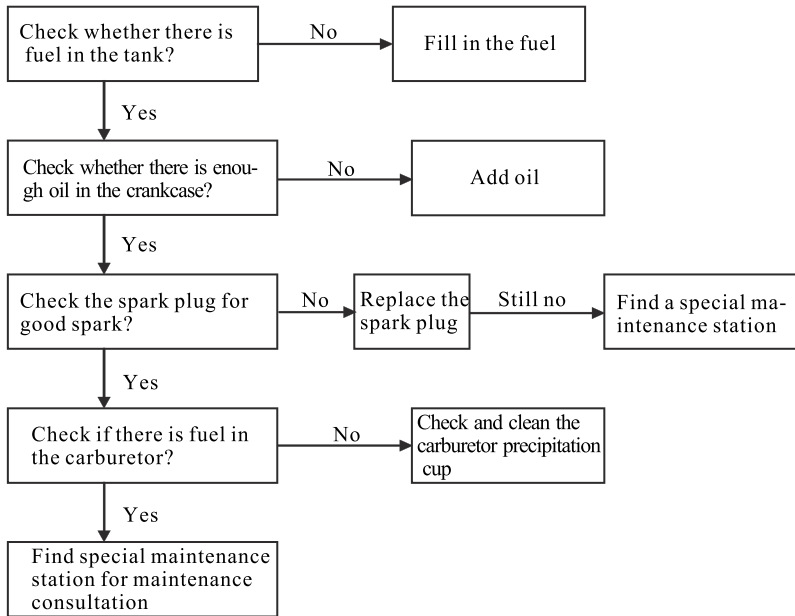

There is no voltage :

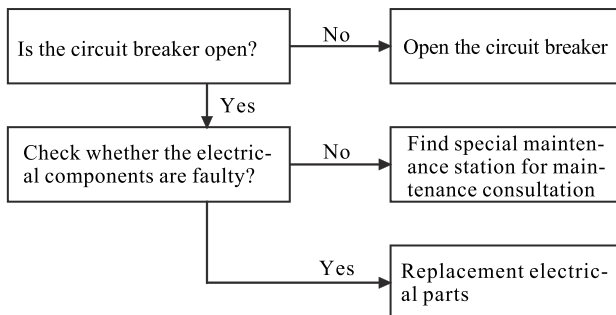

11. WIRING DIAGRAM

5000i Electrical schematic diagram

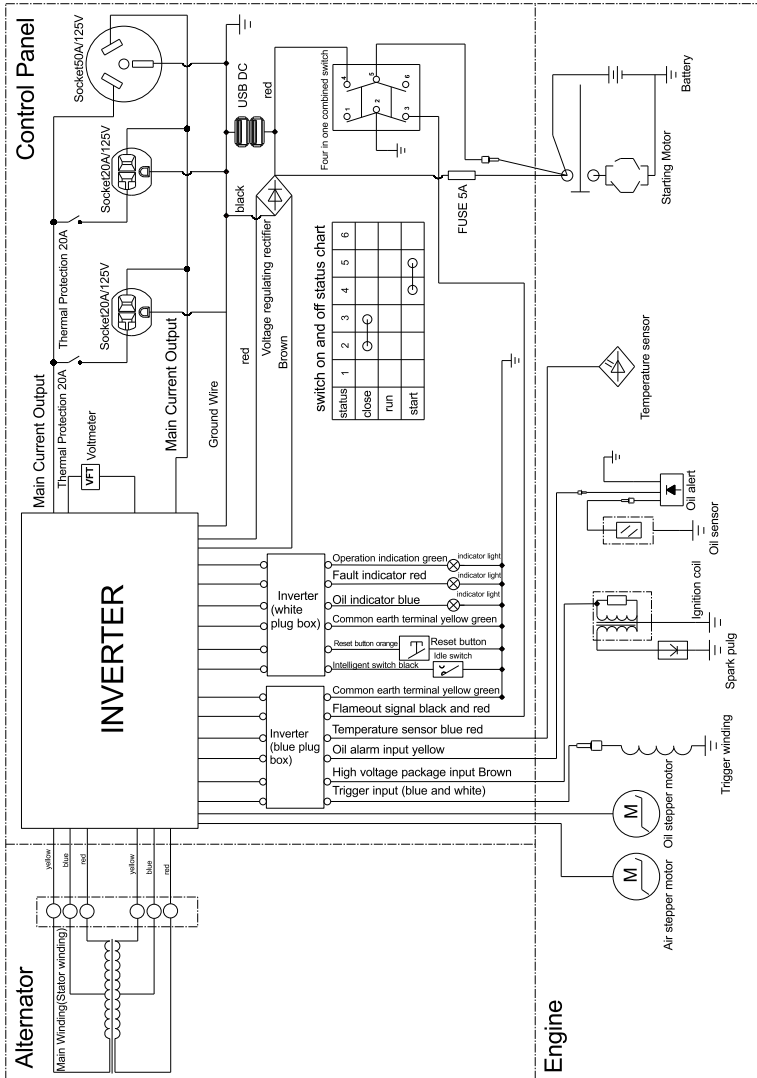

12. SPECIFICATIONS

	Item	5000i
Gasoline Engine	Gasoline Engine Type	Single Cylinder, 4-Stroke, Forced Air Cooling, OHV
	Displacement (cc)	312
	Igniting System	CDI
	Oil Capacity (L)	0.85
Generator	Fuel Volume (L)	15.5
	Rated Frequency (Hz)	50/60
	Rated Voltage (V)	230/120/240
	Rated Output Power	5
	Maximum Output Power (kW)	5.5
	DC(V/A)	12/8.3
Generator Set	Length (mm)	635
	Width (mm)	470
	Height (mm)	530
General-Purpose Accessory	Large Air Cleaner	●
	Large Muffler	●
	Large Fuel Tank	●
	Fuel Gauge	●
	Voltmeter	●
	Automatic Voltage Regulator(AVR)	●
	Oil Alert System	●
	Non-fuse Breaker	●
Electric Starting Accessory	●	

Remarks: ● means available, - means unavailable

Warranty

As part of an on-going commitment to excellence in product support, Euroquip offers a comprehensive product warranty program.

1. THIS WARRANTY:

The benefits provided to the consumer in this warranty are in addition to other rights and remedies of a consumer under the New Zealand Consumer Guarantees Act 1993 and any other laws in relation to the products to which this warranty relates. This warranty:

- Covers the product against faulty materials or workmanship; and
- Covers the replacement of parts, the repair labour used, a refund of the price of the product or replacement of the machine, or other compensation for the remainder of the warranty period.

This product warranty is only applicable to the original purchaser of the machine and only purchases made from Euroquip Authorized Retailers.

2) WARRANTY PERIODS:

Domestic/Commercial: 12 Months

Or

1000 hours of operation – whichever occurs first.

Domestic Warranty applies to domestic use of the product: Personal, residential, or household use only. Commercial Warranty applies to commercial or business use of the product: All uses other than domestic use, including use for income-producing (including farming) or rental purposes.

*These Powertec Warranty periods are for products that are:

- Serviced by a Powertec Dealer in accordance with the Powertec service schedule, using genuine parts and the correct grade of oil (proof required)
- Meeting all other warranty requirements

NOTE: These warranty conditions apply to New Zealand only.

Euroquip warrants each new Powertec machine free from defect in material and workmanship under normal use and routine servicing, for the warranty periods specified. Conditional to the limitations and exclusions list below. The warranty period begins when the product is purchased by the end user. Warranty is not transferrable and is only claimable by the original purchaser.

Proof of purchase documentation with product serial number must be provided. If it has been lost and Euroquip does not have a record of the purchaser's details, the warranty period shall be calculated from the appropriate dealer wholesale sale date.

The purchaser must keep a record of all service and maintenance history as proof of servicing history. This may be requested when assessing any future warranty claims. The decision that an issue with a product qualifies as a warranty claim is made at the sole jurisdiction of Euroquip.

No costs incurred will be considered under warranty if repairs or maintenance are carried out by any party other than a Euroquip Approved Service Agent, unless with prior consent in writing from Euroquip.

It is the full responsibility of the purchaser to deliver the product under warranty to the nearest relevant service agent or product reseller. Warranty does not cover transportation costs including call outs, mileage and freight costs.

Customers are responsible for the care and cleaning of their product prior to sending it to our service centre. Any product being sent us must be thoroughly cleaned. Depending on what the product has come into contact with, it could pose an Occupational/ Work Health and Safety risk for our staff and or/service agents to inspect, repair or service a product that has come into contact with a hazardous substance. If we are asked to inspect, repair or service a product that has come into contact with a hazardous substance such as chemicals, asbestos or silica dust, we may not be able to inspect, service or repair the product. If this is the case, we will inform the purchaser and the product will be returned.

If a product is repaired under warranty, parts and labour required for the repair will be supplied at no charge. All defective parts replaced under warranty become property of Euroquip. Consumable items such as, but not limited to, oils, coolants, filter and spark plugs shall be the responsibility of the owner. Warranty assessment and repair will be scheduled and executed according to the normal work flow at the service location and depending on the availability of suitable replacement parts.

This warranty policy is an additional benefit and does not supersede the legal rights of any customer, reseller or service agent.

Should any issue be found to be a combination of a warranty failure and a non-warranty issue such as incorrect charging techniques, the repair cost component to rectify and repair the non-warranty failure is the **customer's** full responsibility.

3) EXCLUSIONS:

- Warranty does not cover parts that are subject to wear and tear from usage and/or damage which results from neglect of periodic maintenance.
- Evidence must be provided that the product has been maintained and serviced suitably for a claim to be considered under warranty.
- Batteries supplied with your product are warrantied against defect for 3 months and does not include lack of charge due to non-use. Consumable items such as, but not limited to, oils, coolants, filters, spark plugs and batteries shall be the responsibility of the purchaser.
- Failure caused by incorrect operation of the product as specified in the manual either intentionally or by error.
- Lack of proper care and maintenance of the product.
- Any damage which results from unavoidable natural disasters, fire, collision, theft, etc.
- Any normal wear or deterioration, such as that of sliding or rotating parts caused under normal operating conditions.
- Any damage that results from misuse or use beyond the imitations of the products intended purpose (such as overloading or use under abnormal conditions).
- External circumstances such as product deterioration or corrosion due to environmental conditions like heat, cold, salt spray, sand or due to the passage of time
- Normal phenomena such as noise, vibration or oil seepage which are considered by Euroquip as not affecting the quality, function or performance of the product.
- Any damage due to improper storage or transport.
- Consumable replacement items: Spark plugs, contact points, shear pins, fuel strainers, oil filter elements, air cleaner elements, brake shoes or pads, clutch components, fuses, motor brushes, gaskets, tube or hoses, belts, cutting blades, light bulbs, serviceable bearings. Petroleum and others fluids: Oil, grease, battery electrolyte, and radiator coolant. Other items specified by Euroquip.
- Periodical maintenance items such as cleaning, inspection and adjustments.
- Contaminated fuel
- Modifications or installations of other products to the product
- Damage that results from the use of non-genuine parts, lubricant or fluid not approved by Euroquip
- Any repair and/or adjustment to correct improper or poor quality work previously performed.
- Attempted repair/ service by a party other than an Approved Service Agent, or any repair undertaken prior to approval of warranty by Euroquip is not covered under warranty.
- Warranty does not cover pre delivery service and adjustment, or failure that may occur as a result of lack of/ incorrect pre delivery service and adjustment. Warranty does not cover any incidental, indirect or consequential loss, damage, personal injury, or expense that may result from any defect, failure, malfunction, or misuse of a product.
- Any product that is found to have come into contact with hazardous substances such as chemicals, asbestos or silica dust and NOT been industrially cleaned prior to servicing.

4) HOW TO CLAIM WARRANTY:

In the event you are faced with a manufacturing fault with your Powertec product, you can claim a repair or part replacement under warranty if the following conditions are fulfilled:

- The problem is related to production quality or specifications of the machine
- The machine is within the warranty period outlined in schedule
- The issue does not fall within the warranty exclusions listed

If the criteria above is met, and you would like to request a warranty, then please go online to <https://www.euroquip.co.nz/Service-Request-End-User> and log your warranty claim.



Congratulations on your new **POWERTEC** product. We are proud to have you as our customer and will strive to provide you with the best service and reliability in the industry. This product is backed by our extensive warranty and service network. Please contact your local agent or submit a service case online for fast response at www.powertec.net.nz