

## G 3613DVE • G 3613DVF

---

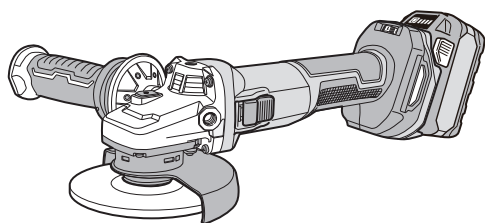

G3613DVE

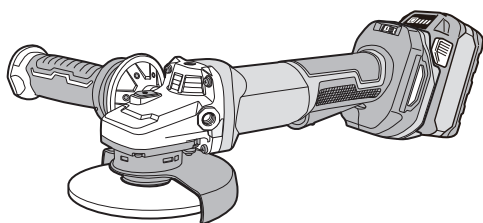

G3613DVF



Handling instructions

1

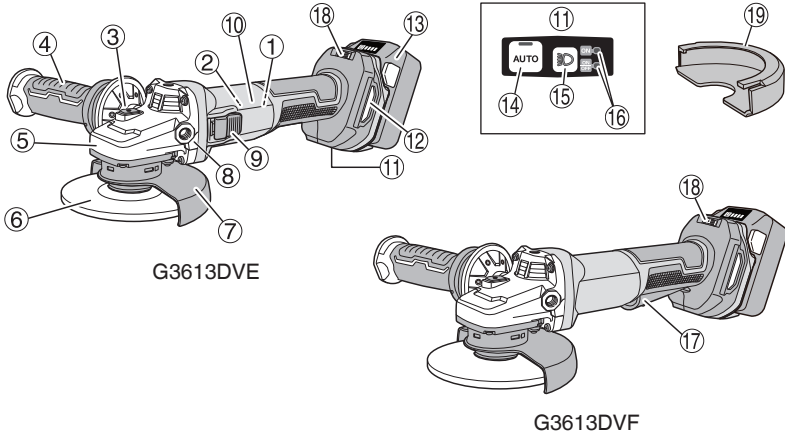

2

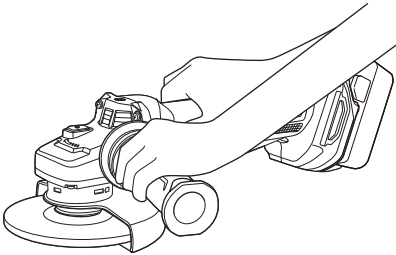

3

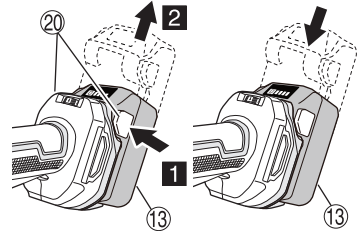

4

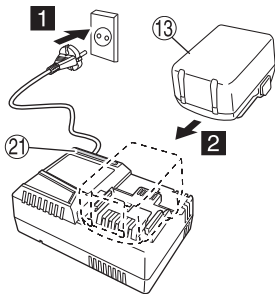

5

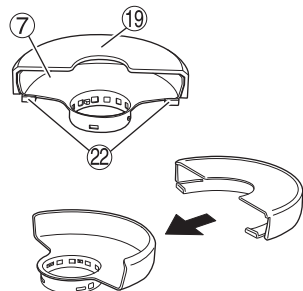

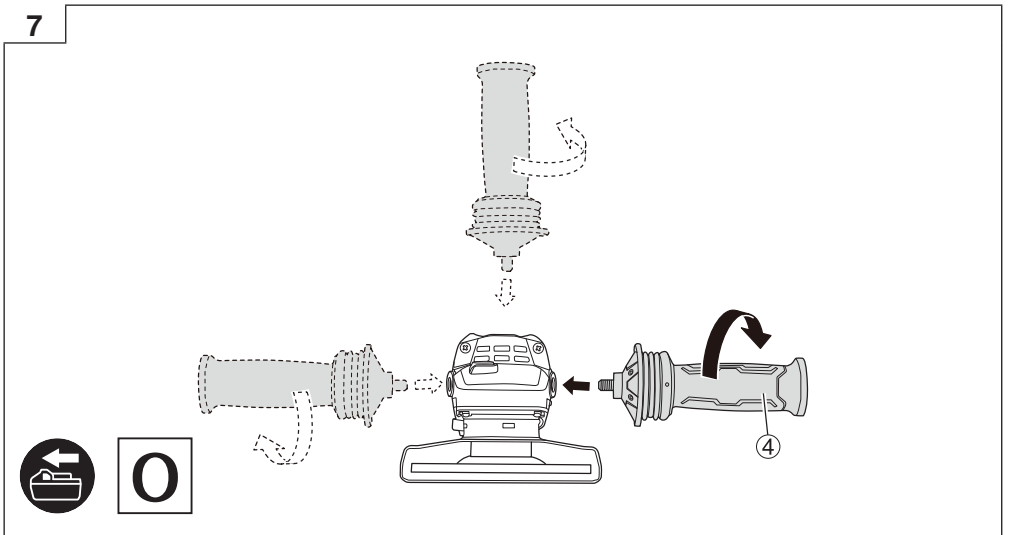
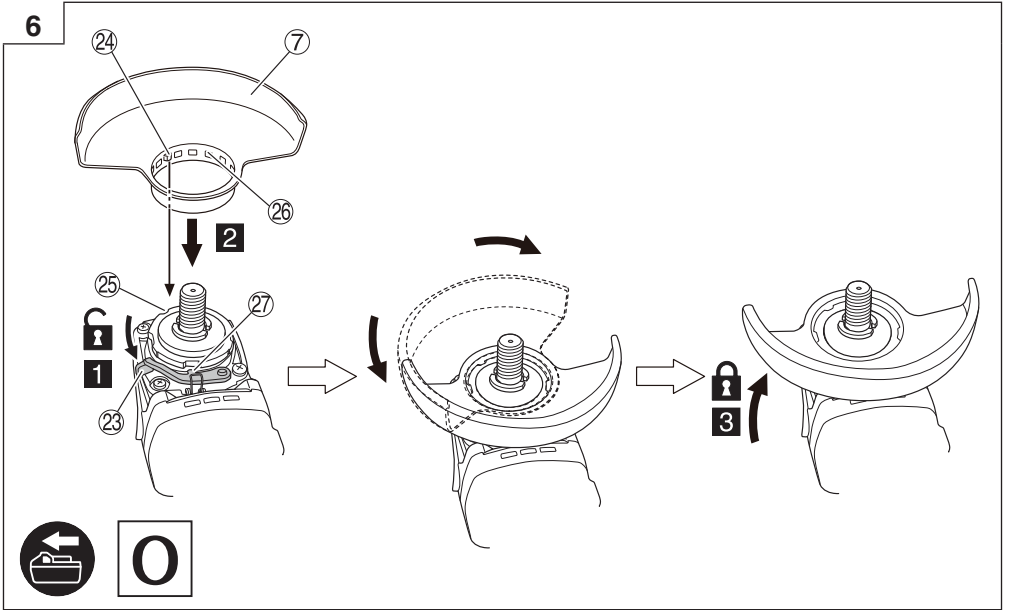

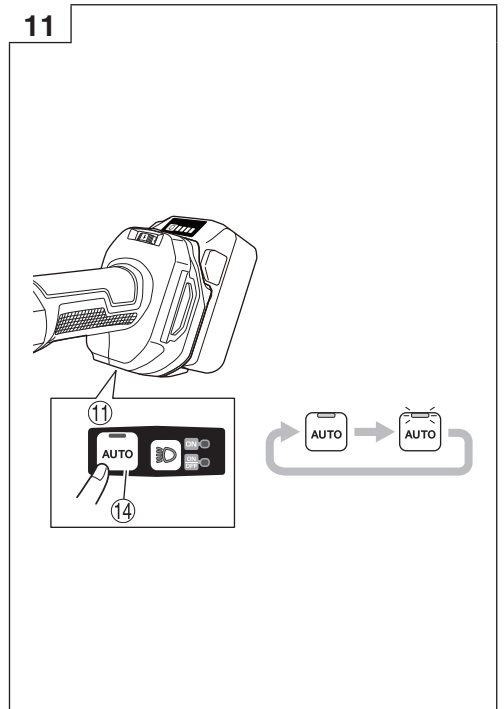
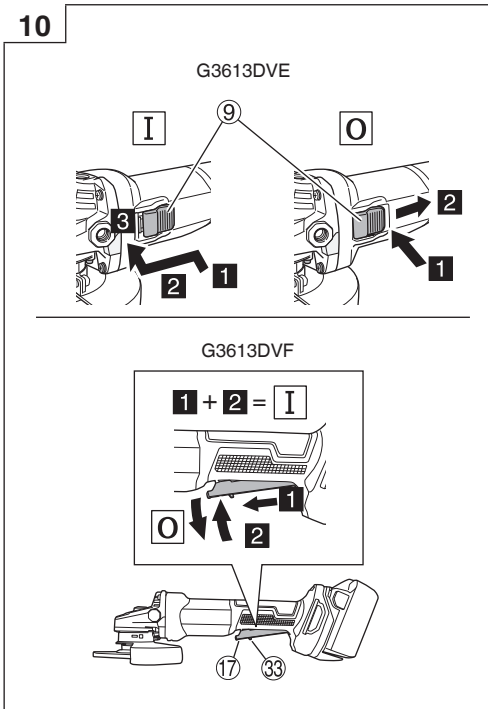
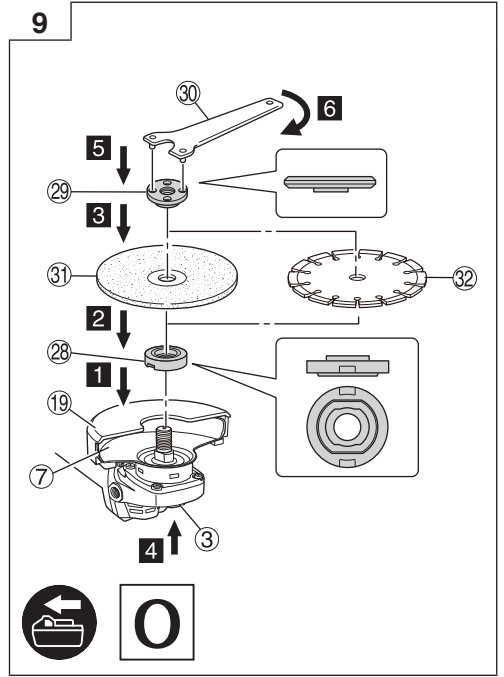
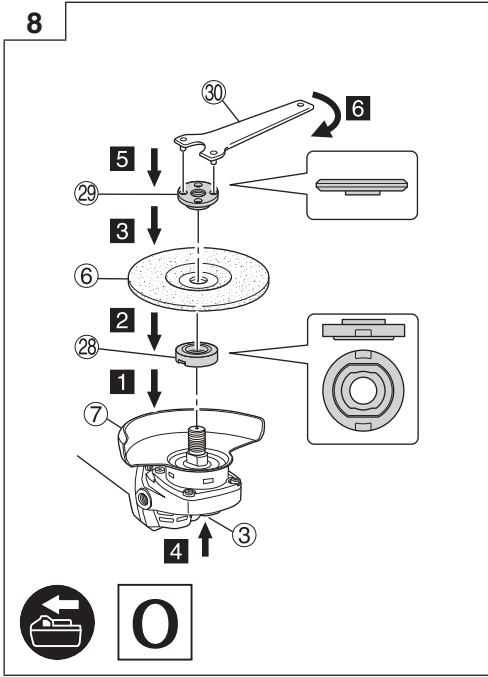

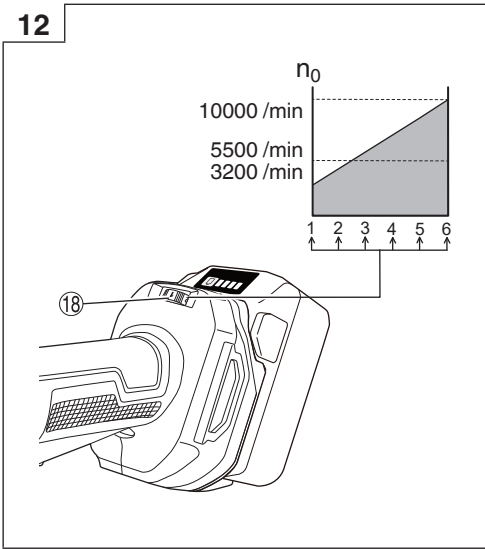
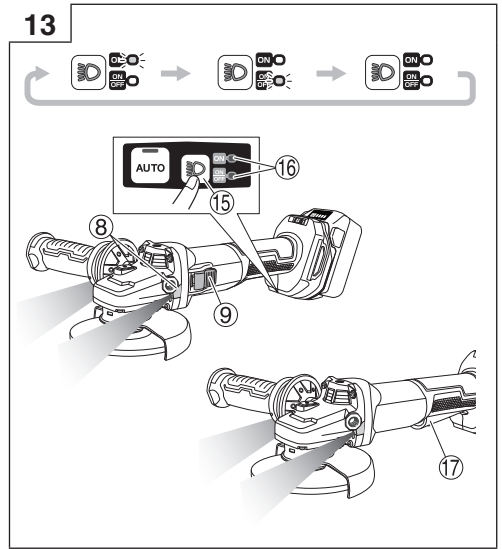
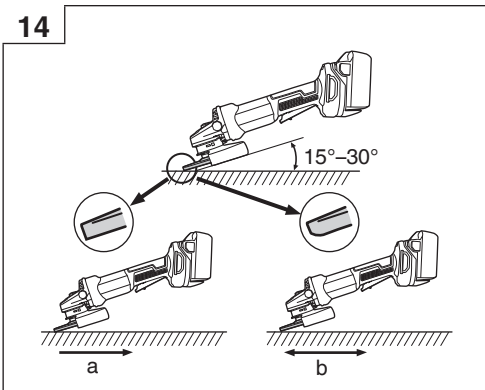
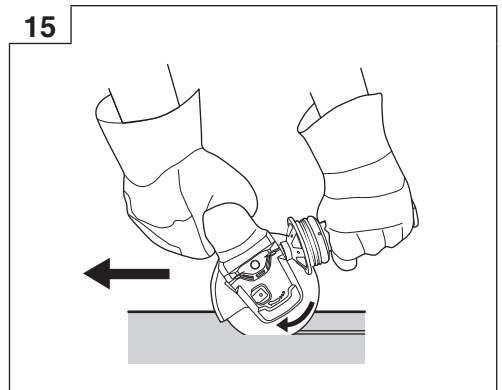
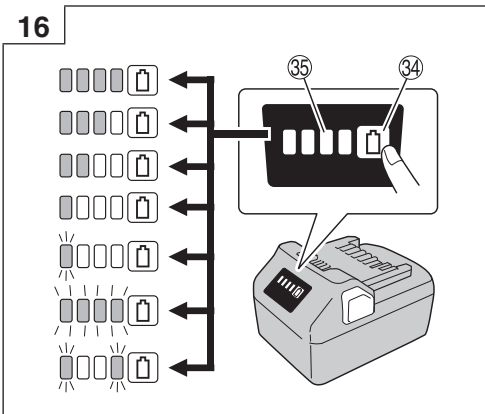
**12****13****14****15****16**

17

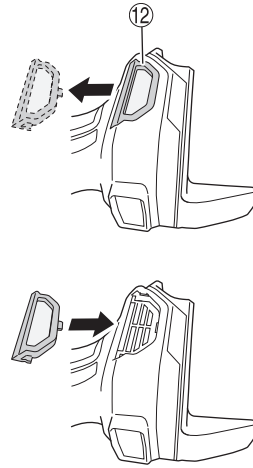
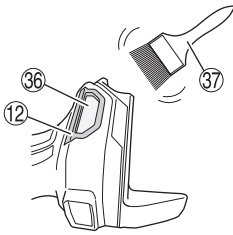

18

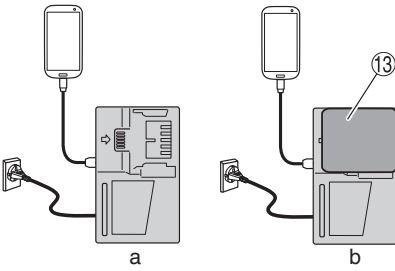

19

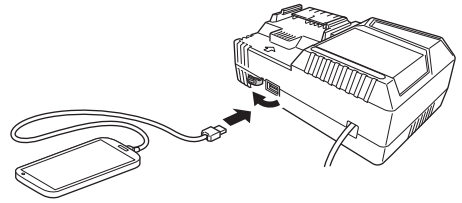

20

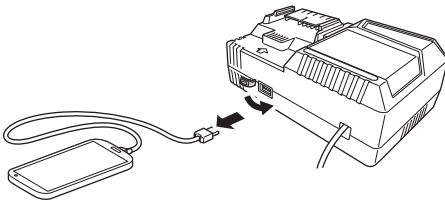

## GENERAL POWER TOOL SAFETY WARNINGS

### WARNING

Read all safety warnings, instructions, illustrations and specifications provided with this power tool.

Failure to follow all instructions listed below may result in electric shock, fire and/or serious injury.

Save all warnings and instructions for future reference.

The term "power tool" in the warnings refers to your mains-operated (corded) power tool or battery-operated (cordless) power tool.

#### 1) Work area safety

- a) **Keep work area clean and well lit.**  
*Cluttered or dark areas invite accidents.*
- b) **Do not operate power tools in explosive atmospheres, such as in the presence of flammable liquids, gases or dust.**  
*Power tools create sparks which may ignite the dust or fumes.*
- c) **Keep children and bystanders away while operating a power tool.**  
*Distractions can cause you to lose control.*

#### 2) Electrical safety

- a) **Power tool plugs must match the outlet. Never modify the plug in any way. Do not use any adapter plugs with earthed (grounded) power tools.**  
*Unmodified plugs and matching outlets will reduce risk of electric shock.*
- b) **Avoid body contact with earthed or grounded surfaces, such as pipes, radiators, ranges and refrigerators.**  
*There is an increased risk of electric shock if your body is earthed or grounded.*
- c) **Do not expose power tools to rain or wet conditions.**  
*Water entering a power tool will increase the risk of electric shock.*
- d) **Do not abuse the cord. Never use the cord for carrying, pulling or unplugging the power tool. Keep cord away from heat, oil, sharp edges or moving parts.**  
*Damaged or entangled cords increase the risk of electric shock.*
- e) **When operating a power tool outdoors, use an extension cord suitable for outdoor use.**  
*Use of a cord suitable for outdoor use reduces the risk of electric shock.*
- f) **If operating a power tool in a damp location is unavoidable, use a residual current device (RCD) protected supply.**  
*Use of an RCD reduces the risk of electric shock.*

#### 3) Personal safety

- a) **Stay alert, watch what you are doing and use common sense when operating a power tool. Do not use a power tool while you are tired or under the influence of drugs, alcohol or medication.**  
*A moment of inattention while operating power tools may result in serious personal injury.*
- b) **Use personal protective equipment. Always wear eye protection.**  
*Protective equipment such as a dust mask, non-skid safety shoes, hard hat or hearing protection used for appropriate conditions will reduce personal injuries.*

- c) **Prevent unintentional starting. Ensure the switch is in the off-position before connecting to power source and/or battery pack, picking up or carrying the tool.**

*Carrying power tools with your finger on the switch or energising power tools that have the switch on invites accidents.*

- d) **Remove any adjusting key or wrench before turning the power tool on.**

*A wrench or a key left attached to a rotating part of the power tool may result in personal injury.*

- e) **Do not overreach. Keep proper footing and balance at all times.**

*This enables better control of the power tool in unexpected situations.*

- f) **Dress properly. Do not wear loose clothing or jewellery. Keep your hair and clothing away from moving parts.**

*Loose clothes, jewellery or long hair can be caught in moving parts.*

- g) **If devices are provided for the connection of dust extraction and collection facilities, ensure these are connected and properly used.**

*Use of dust collection can reduce dust-related hazards.*

- h) **Do not let familiarity gained from frequent use of tools allow you to become complacent and ignore tool safety principles.**

*A careless action can cause severe injury within a fraction of a second.*

#### 4) Power tool use and care

- a) **Do not force the power tool. Use the correct power tool for your application.**  
*The correct power tool will do the job better and safer at the rate for which it was designed.*
- b) **Do not use the power tool if the switch does not turn it on and off.**  
*Any power tool that cannot be controlled with the switch is dangerous and must be repaired.*
- c) **Disconnect the plug from the power source and/or remove the battery pack, if detachable, from the power tool before making any adjustments, changing accessories, or storing power tools.**  
*Such preventive safety measures reduce the risk of starting the power tool accidentally.*
- d) **Store idle power tools out of the reach of children and do not allow persons unfamiliar with the power tool or these instructions to operate the power tool.**  
*Power tools are dangerous in the hands of untrained users.*
- e) **Maintain power tools and accessories. Check for misalignment or binding of moving parts, breakage of parts and any other condition that may affect the power tool's operation. If damaged, have the power tool repaired before use.**  
*Many accidents are caused by poorly maintained power tools.*
- f) **Keep cutting tools sharp and clean.**  
*Properly maintained cutting tools with sharp cutting edges are less likely to bind and are easier to control.*
- g) **Use the power tool, accessories and tool bits etc. in accordance with these instructions, taking into account the working conditions and the work to be performed.**  
*Use of the power tool for operations different from those intended could result in a hazardous situation.*

- h) **Keep handles and grasping surfaces dry, clean and free from oil and grease.**  
*Slippery handles and grasping surfaces do not allow for safe handling and control of the tool in unexpected situations.*
- 5) **Battery tool use and care**
- a) **Recharge only with the charger specified by the manufacturer.**  
*A charger that is suitable for one type of battery pack may create a risk of fire when used with another battery pack.*
- b) **Use power tools only with specifically designated battery packs.**  
*Use of any other battery packs may create a risk of injury and fire.*
- c) **When battery pack is not in use, keep it away from other metal objects, like paper clips, coins, keys, nails, screws or other small metal objects, that can make a connection from one terminal to another.**  
*Shorting the battery terminals together may cause burns or a fire.*
- d) **Under abusive conditions, liquid may be ejected from the battery; avoid contact. If contact accidentally occurs, flush with water. If liquid contacts eyes, additionally seek medical help.**  
*Liquid ejected from the battery may cause irritation or burns.*
- e) **Do not use a battery pack or tool that is damaged or modified.**  
*Damaged or modified batteries may exhibit unpredictable behaviour resulting in fire, explosion or risk of injury.*
- f) **Do not expose a battery pack or tool to fire or excessive temperature.**  
*Exposure to fire or temperature above 130°C may cause explosion.*
- g) **Follow all charging instructions and do not charge the battery pack or tool outside the temperature range specified in the instructions.**  
*Charging improperly or at temperatures outside the specified range may damage the battery and increase the risk of fire.*
- 6) **Service**
- a) **Have your power tool serviced by a qualified repair person using only identical replacement parts.**  
*This will ensure that the safety of the power tool is maintained.*
- b) **Never service damaged battery packs.**  
*Service of battery packs should only be performed by the manufacturer or authorized service providers.*

## PRECAUTION

Keep children and infirm persons away.

When not in use, tools should be stored out of reach of children and infirm persons.

## SAFETY WARNINGS COMMON FOR GRINDING OR ABRASIVE CUTTING-OFF OPERATIONS

- a) **This power tool is intended to function as a grinder or cut-off tool. Read all safety warnings, instructions, illustrations and specifications provided with this power tool.**  
*Failure to follow all instructions listed below may result in electric shock, fire and/or serious injury.*
- b) **Operations such as sanding, wire brushing, polishing or hole cutting are not recommended to be performed with this power tool.**  
*Operations for which the power tool was not designed may create a hazard and cause personal injury.*
- c) **Do not convert this power tool to operate in a way which is not specifically designed and specified by the tool manufacturer.**  
*Such a conversion may result in a loss of control and cause serious personal injury.*
- d) **Do not use accessories which are not specifically designed and specified by the tool manufacturer.**  
*Just because the accessory can be attached to your power tool, it does not ensure safe operation.*
- e) **The rated speed of the accessory must be at least equal to the maximum speed marked on the power tool.**  
*Accessories running faster than their rated speed can break and fly apart.*
- f) **The outside diameter and the thickness of your accessory must be within the capacity rating of your power tool.**  
*Incorrectly sized accessories cannot be adequately guarded or controlled.*
- g) **The dimensions of the accessory mounting must fit the dimensions of the mounting hardware of the power tool.**  
*Accessories that do not match the mounting hardware of the power tool will run out of balance, vibrate excessively and may cause loss of control.*
- h) **Do not use a damaged accessory. Before each use inspect the accessory such as abrasive wheels for chips and cracks, backing pad for cracks, tear or excess wear, wire brush for loose or cracked wires. If power tool or accessory is dropped, inspect for damage or install an undamaged accessory. After inspecting and installing an accessory, position yourself and bystanders away from the plane of the rotating accessory and run the power tool at maximum no-load speed for one minute.**  
*Damaged accessories will normally break apart during this test time.*
- i) **Wear personal protective equipment. Depending on application, use face shield, safety goggles or safety glasses. As appropriate, wear dust mask, hearing protectors, gloves and workshop apron capable of stopping small abrasive or workpiece fragments.**  
*The eye protection must be capable of stopping flying debris generated by various operations. The dust mask or respirator must be capable of filtering particles generated by your operation. Prolonged exposure to high intensity noise may cause hearing loss.*
- j) **Keep bystanders a safe distance away from work area. Anyone entering the work area must wear personal protective equipment.**  
*Fragments of workpiece or of a broken accessory may fly away and cause injury beyond immediate area of operation.*
- k) **Hold the power tool by insulated gripping surfaces only, when performing an operation where the cutting tool may contact hidden wiring.**  
*Contact with a "live" wire will also make exposed metal parts of the power tool "live" and could give the operator an electric shock.*
- l) **Position the cord clear of the spinning accessory.**  
*If you lose control, the cord may be cut or snagged and your hand or arm may be pulled into the spinning accessory.*



- m) Never lay the power tool down until the accessory has come to a complete stop.

*The spinning accessory may grab the surface and pull the power tool out of your control.*

- n) Do not run the power tool while carrying it at your side.

*Accidental contact with the spinning accessory could snag your clothing, pulling the accessory into your body.*

- o) Regularly clean the power tool's air vents.

*The motor's fan will draw the dust inside the housing and excessive accumulation of powdered metal may cause electrical hazards.*

- p) Do not operate the power tool near flammable materials.

*Sparks could ignite these materials.*

- q) Do not use accessories that require liquid coolants.

*Using water or other liquid coolants may result in electrocution or shock.*

## KICKBACK AND RELATED WARNINGS

*Kickback is a sudden reaction to a pinched or snagged rotating wheel, backing pad, brush or any other accessory. Pinching or snagging causes rapid stalling of the rotating accessory which in turn causes the uncontrolled power tool to be forced in the direction opposite of the accessory's rotation at the point of the binding.*

*For example, if an abrasive wheel is snagged or pinched by the workpiece, the edge of the wheel that is entering into the pinch point can dig into the surface of the material causing the wheel to climb out or kick out. The wheel may either jump toward or away from the operator, depending on direction of the wheel's movement at the point of pinching.*

*Abrasive wheels may also break under these conditions.*

*Kickback is the result of power tool misuse and/or incorrect operating procedures or conditions and can be avoided by taking proper precautions as given below.*

- a) Maintain a firm grip with both hands on the power tool and position your body and arm to allow you to resist kickback forces. Always use auxiliary handle, if provided, for maximum control over kickback or torque reaction during start-up.

*The operator can control torque reactions or kickback forces, if proper precautions are taken.*

- b) Never place your hand near the rotating accessory.

*Accessory may kickback over your hand.*

- c) Do not position your body in the area where power tool will move if kickback occurs.

*Kickback will propel the tool in direction opposite to the wheel's movement at the point of snagging.*

- d) Use special care when working corners, sharp edges etc. Avoid bouncing and snagging the accessory.

*Corners, sharp edges or bouncing have a tendency to snag the rotating accessory and cause loss of control or kickback.*

- e) Do not attach a saw chain woodcarving blade, segmented diamond wheel with a peripheral gap greater than 10 mm or toothed saw blade.

*Such blades create frequent kickback and loss of control.*

## SAFETY WARNINGS SPECIFIC FOR GRINDING AND ABRASIVE CUTTING-OFF OPERATIONS

- a) Use only wheel types that are specified for your power tool and the specific guard designed for the selected wheel.

*Wheels for which the power tool was not designed cannot be adequately guarded and are unsafe.*

- b) The grinding surface of centre depressed wheels must be mounted below the plane of the guard lip.

*An improperly mounted wheel that projects through the plane of the guard lip cannot be adequately protected.*

- c) The guard must be securely attached to the power tool and positioned for maximum safety, so the least amount of wheel is exposed towards the operator.

*The guard helps to protect the operator from broken wheel fragments, accidental contact with wheel and sparks that could ignite clothing.*

- d) Wheels must be used only for specified applications. For example: do not grind with the side of cut-off wheel.

*Abrasive cut-off wheels are intended for peripheral grinding, side forces applied to these wheels may cause them to shatter.*

- e) Always use undamaged wheel flanges that are of correct size and shape for your selected wheel.

*Proper wheel flanges support the wheel thus reducing the possibility of wheel breakage. Flanges for cut-off wheels may be different from grinding wheel flanges.*

- f) Do not use worn down wheels from larger power tools.

*A wheel intended for larger power tool is not suitable for the higher speed of a smaller tool and may burst.*

- g) When using dual purpose wheels always use the correct guard for the application being performed.

*Failure to use the correct guard may not provide the desired level of guarding, which could lead to serious injury.*

## ADDITIONAL SAFETY WARNINGS SPECIFIC FOR ABRASIVE CUTTING-OFF OPERATIONS

- a) Do not "jam" the cut-off wheel or apply excessive pressure. Do not attempt to make an excessive depth of cut.

*Overstressing the wheel increases the loading and susceptibility to twisting or binding of the wheel in the cut and the possibility of kickback or wheel breakage.*

- b) Do not position your body in line with and behind the rotating wheel.

*When the wheel, at the point of operation, is moving away from your body, the possible kickback may propel the spinning wheel and the power tool directly at you.*

- c) When the wheel is binding or when interrupting a cut for any reason, switch off the power tool and hold it motionless until the wheel comes to a complete stop. Never attempt to remove the cut-off wheel from the cut while the wheel is in motion otherwise kickback may occur.

*Investigate and take corrective action to eliminate the cause of wheel binding.*

- d) Do not restart the cutting operation in the workpiece. Let the wheel reach full speed and carefully re-enter the cut.

*The wheel may bind, walk up or kickback if the power tool is restarted in the workpiece.*

- e) **Support panels or any oversized workpiece to minimize the risk of wheel pinching and kickback.**  
*Large workpieces tend to sag under their own weight. Supports must be placed under the workpiece near the line of cut and near the edge of the workpiece on both sides of the wheel.*
  - f) **Use extra caution when making a “pocket cut” into existing walls or other blind areas.**  
*The protruding wheel may cut gas or water pipes, electrical wiring or objects that can cause kickback.*
  - g) **Do not attempt to do curved cutting.**  
*Overstressing the wheel increases the loading and susceptibility to twisting or binding of the wheel in the cut and the possibility of kickback or wheel breakage, which can lead to serious injury.*
- When using a type A, B wheel guard for cutting-off operations or lateral grinding in concrete or masonry, there is an increased risk of exposure to dust and loss of control resulting in kickback.
  - Do not use any segmented diamond cut-off wheels with segment slits >10 mm. Only negative segment cutting angles are permitted.
  - The workpiece must lay flat and be secured against slipping, e.g. using clamps. Large workpieces must be sufficiently supported.
  - Observe the specifications of the tool or accessory manufacturer. Protect wheels from grease or impact.
  - Accessories must be stored and handled with care in accordance with the manufacturer’s instructions.

### **⚠ WARNING**

- When using a cutting-off wheel, be sure to attach a type A wheel guard.
- When using a grinding wheel, be sure to attach a type B wheel guard.
- For safety reasons, only use the wheel guard provided for the respective accessory. Using an incorrect wheel guard can lead to loss of control and serious injuries. See also page 19.

## **GENERAL SAFETY INSTRUCTIONS FOR CORDLESS DISC GRINDERS**

- Attach the side handle firmly, hold the housing and the side handle with both hands, and support the tool body securely. (Fig. 2)
- Check that speed marked on the wheel is equal to or greater than the rated speed of the grinder;
- Ensure that the wheel dimensions are compatible with the grinder;
- Inspect the grinding wheel before use, do not use chipped, cracked or otherwise defective products;
- Ensure that mounted wheels and points are fitted in accordance with the manufacturer’s instructions;
- Ensure that blotters are used when they are provided with the bonded abrasive product and when they are required;
- Ensure that the abrasive product is correctly mounted and tightened before use and run the tool at no-load for 30 seconds in a safe position, stop immediately if there is considerable vibration or if other defects are detected. If this condition occurs, check the machine to determine the cause;
- If a guard is equipped with the tool never use the tool without such a guard;
- Do not use separate reducing bushings or adapters to adapt large hole abrasive wheels;
- For tools intended to be fitted with threaded hole wheel, ensure that the thread in the wheel is long enough to accept the spindle length;
- Do not use cutting off wheel for side grinding;
- Ensure that sparks resulting from use do not create a hazard e.g. do not hit persons, or ignite flammable substances;
- Ensure that ventilation openings are kept clear when working in dusty conditions, if it should become necessary to clear dust, first disconnect the tool from the mains supply (use non metallic objects) and avoid damaging internal parts;
- Always use eye and ear protection. Other personal protective equipment such as dust mask, gloves, helmet and apron should be worn;
- Pay attention to the wheel that continues to rotate after the tool is switched off.
- When using dual-purpose (combined grinding and cut-off wheels), use only the type A wheel guard. (See page 19)
- When using a type A wheel guard for lateral grinding, the guard may interfere with the workpiece causing poor control.
- When using a type B wheel guard for cutting-off operations with bonded cut-off wheels, there is an increased risk of exposure to emitted sparks and particles, as well as exposure to wheel fragments in the event of a wheel burst.

## **ADDITIONAL SAFETY WARNINGS**

1. Ensure that the depressed center wheel to be utilized is the correct type and free of cracks or surface defects. Also ensure that the depressed center wheel is properly mounted and the wheel nut is securely tightened.
2. Confirm that the push button is disengaged by pushing push button two or three times before switching the power tool on.
3. To prolong the life of the machine and ensure a first class finish, it is important that the machine should not be overloaded by applying too much pressure. In most applications, the weight of the machine alone is sufficient for effective grinding. Too much pressure will result in reduced rotational speed, inferior surface finish, and overloading which could reduce the life of the machine.
4. The wheel continues to rotate after the tool is switched off.  
After switching off the machine, do not put it down until the depressed center wheel has come to a complete stop. Apart from avoiding serious accidents, this precaution will reduce the amount of dust and swarf sucked into the machine.
5. When the machine is not use, the power source should be disconnected.
6. Be sure to switch OFF and pull out the battery to avoid a serious accident before the depressed center wheel is assembling and disassembling.
7. Be careful of brake kickback.  
This cordless disc grinder features an electric brake that functions when the switch is released. As there is some kickback when the brake functions, be sure to hold the main body securely.
8. If you notice that the unit is generating unusually high temperatures, operating poorly, or making abnormal noises, immediately stop using and shut off the power switch. Request an inspection and repair from the dealer where you purchased the unit or a HiKOKI Authorized Service Center.  
Continuing to use while operating abnormally might cause injuries.
9. If the unit is mistakenly dropped or strikes another object, make a thorough check of the unit for cracks, breakage or deformation, etc.  
Injuries might occur if the unit has cracks, breakage or deformation.

10. When working at elevated locations, clear the area of other people and aware of conditions below you.

11. Always charge the battery at a temperature of 0°C–40°C. A temperature of less than 0°C will result in over charging which is dangerous. The battery cannot be charged at a temperature higher than 40°C.

The most suitable temperature for charging is that of 20°C–25°C.

12. Do not use the charger continuously.

When one charging is completed, leave the charger for about 15 minutes before the next charging of battery.

13. Do not allow foreign matter to enter the hole for connecting the rechargeable battery.

14. Never disassemble the rechargeable battery and charger.

15. Never short-circuit the rechargeable battery. Shortcircuiting the battery will cause a great electric current and overheat. It results in burn or damage to the battery.

16. Do not dispose of the battery in fire. If the battery is burnt, it may explode.

17. Bring the battery to the shop from which it was purchased as soon as the post-charging battery life becomes too short for practical use. Do not dispose of the exhausted battery.

18. Do not insert object into the air ventilation slots of the charger. Inserting metal objects or inflammables into the charger air ventilation slots will result in electrical shock hazard or damaged charger.

19. When using this unit continuously, the unit may overheat, leading to damage in the motor and switch. Therefore, whenever the housing becomes hot, give the tool a break for a while.

20. Make sure that the battery is installed firmly. If it is at all loose it could come off and cause an accident.

21. Do not use the product if the tool or the battery terminals (battery mount) are deformed.

Installing the battery could cause a short circuit that could result in smoke emission or ignition.

22. Keep the tool's terminals (battery mount) free of swarf and dust.

○ Prior to use, make sure that swarf and dust have not collected in the area of the terminals.

○ During use, try to avoid swarf or dust on the tool from falling on the battery.

○ When suspending operation or after use, do not leave the tool in an area where it may be exposed to falling swarf or dust.

Doing so could cause a short circuit that could result in smoke emission or ignition.

23. Always use the tool and battery at temperatures between -5°C and 40°C.

## CAUTION ON LITHIUM-ION BATTERY

To extend the lifetime, the lithium-ion battery equips with the protection function to stop the output.

In the cases of 1 to 3 described below, when using this product, even if you are pulling the switch, the motor may stop. This is not the trouble but the result of protection function.

1. When the battery power remaining runs out, the motor stops.

In such a case, charge it up immediately.

2. If the tool is overloaded, the motor may stop. In this case, release the switch of tool and eliminate causes of overloading. After that, you can use it again.

3. If the battery is overheated under overload work, the battery power may stop.

In this case, stop using the battery and let the battery cool. After that, you can use it again.

Furthermore, please heed the following warning and caution.

### WARNING

In order to prevent any battery leakage, heat generation, smoke emission, explosion and ignition beforehand, please be sure to heed the following precautions.

1. Make sure that swarf and dust do not collect on the battery.

○ During work make sure that swarf and dust do not fall on the battery.

○ Make sure that any swarf and dust falling on the power tool during work do not collect on the battery.

○ Do not store an unused battery in a location exposed to swarf and dust.

○ Before storing a battery, remove any swarf and dust that may adhere to it and do not store it together with metal parts (screws, nails, etc.).

2. Do not pierce battery with a sharp object such as a nail, strike with a hammer, step on, throw or subject the battery to severe physical shock.

3. Do not use an apparently damaged or deformed battery.

4. Do not use the battery for a purpose other than those specified.

5. If the battery charging fails to complete even when a specified recharging time has elapsed, immediately stop further recharging.

6. Do not put or subject the battery to high temperatures or high pressure such as into a microwave oven, dryer, or high pressure container.

7. Keep away from fire immediately when leakage or foul odor are detected.

8. Do not use in a location where strong static electricity generates.

9. If there is battery leakage, foul odor, heat generated, discolored or deformed, or in any way appears abnormal during use, recharging or storage, immediately remove it from the equipment or battery charger, and stop use.

10. Do not immerse the battery or allow any fluids to flow inside. Conductive liquid ingress, such as water, can cause damage resulting in fire or explosion. Store your battery in a cool, dry place, away from combustible and flammable items. Corrosive gas atmospheres must be avoided.

### CAUTION

1. If liquid leaking from the battery gets into your eyes, do not rub your eyes and wash them well with fresh clean water such as tap water and contact a doctor immediately.

If left untreated, the liquid may cause eye-problems.

2. If liquid leaks onto your skin or clothes, wash well with clean water such as tap water immediately.

There is a possibility that this can cause skin irritation.

3. If you find rust, foul odor, overheating, discolor, deformation, and/or other irregularities when using the battery for the first time, do not use and return it to your supplier or vendor.

### WARNING

If a conductive foreign matter enters in the terminal of lithium ion battery, the battery may be shorted, causing fire. When storing the lithium ion battery, obey surely the rules of following contents.

○ Do not place conductive debris, nail and wires such as iron wire and copper wire in the storage case.

○ To prevent shorting from occurring, load the battery in the tool or insert securely the battery cover for storing until the ventilator is not seen.

## REGARDING LITHIUM-ION BATTERY TRANSPORTATION

When transporting a lithium-ion battery, please observe the following precautions.

### WARNING

Notify the transporting company that a package contains a lithium-ion battery, inform the company of its power output and follow the instructions of the transportation company when arranging transport.

- Lithium-ion batteries that exceed a power output of 100 Wh are considered to be in the freight classification of Dangerous Goods and will require special application procedures.
- For transportation abroad, you must comply with international law and the rules and regulations of the destination country.

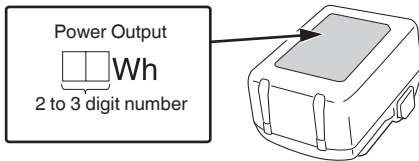

## USB DEVICE CONNECTION PRECAUTIONS (UC18YSL3)

When an unexpected problem occurs, the data in a USB device connected to this product may be corrupted or lost. Always make sure to back up any data contained in the USB device prior to use with this product.

Please be aware that our company accepts absolutely no responsibility for any data stored in a USB device that is corrupted or lost, nor for any damage that may occur to a connected device.

### WARNING

- Prior to use, check the connecting USB cable for any defect or damage.  
Using a defective or damaged USB cable can cause smoke emission or ignition.
- When the product is not being used, cover the USB port with the rubber cover.  
Buildup of dust etc. in the USB port can cause smoke emission or ignition.

### NOTE

- There may be an occasional pause during USB recharging.
- When a USB device is not being charged, remove the USB device from the charger.  
Failure to do so may not only reduce the battery life of a USB device, but may also result in unexpected accidents.
- It may not be possible to charge some USB devices, depending on the type of device.

## NAMES OF PARTS (Fig. 1–Fig. 20)

①	Motor	⑤	Gear cover
②	Nameplate	⑥	Depressed center wheel
③	Push button	⑦	Toolless wheel guard
④	Side handle	⑧	LED light













⑨	Switch	⑳	Notch of body
⑩	Housing	㉑	Hole of wheel guard
⑪	Switch panel	㉒	Bump of lever
⑫	Filter	㉓	Wheel washer (C)
⑬	Battery	㉔	Wheel nut
⑭	Auto mode switch	㉕	Wrench
⑮	Lighting mode switch	㉖	Abrasive cutting wheel (sold separately)
⑯	Lighting mode indicator lamp	㉗	Diamond wheel (sold separately)
⑰	Switch lever	㉘	Off-lock lever
⑱	Dial	㉙	Remaining battery indicator switch
㉚	Guard clip (mounted on wheel guard when packaged)	㉛	Remaining battery indicator lamp
㉜	Latch	㉜	Mesh
㉝	Charge indicator lamp	㉝	Soft brush
㉞	Tabs of guard clip (2 locations)	㉞	Diamond cup wheel (sold separately)
㉟	Lever	㉟	Dust collection adapter (For diamond cup wheel) (sold separately)
㊱	Bump of wheel guard	㊱	Dust collection adapter (For diamond wheel) (sold separately)



## SYMBOLS

### WARNING

The following show symbols used for the machine. Be sure that you understand their meaning before use.

	G3613DVE / G3613DVF: Cordless Disc Grinder
	To reduce the risk of injury, user must read instruction manual.
	Always wear eye protection.
	Always operate the power tool with two hands
	Not for cut-off operations When using a cutting-off wheel, be sure to attach the type A wheel guard. when using a type B wheel guard for cutting-off operations with bonded cut-off wheels, there is an increased risk of exposure to emitted sparks and particles, as well as exposure to wheel fragments in the event of a wheel burst.
V	Rated voltage

$n$	Rated speed
$n_0$	No-load rotation speed
/min	Revolution or reciprocations per minute
A	Auto mode
D	Wheel outer diameter
d	Wheel hole diameter
t	Wheel thickness
	Peripheral speed
	Weight
	Switching ON
	Switching OFF
	Disconnect the battery
	Lock
	Unlock
	Auto mode switch
	Lighting mode switch
	Always ON (turn off after 60 minutes)
	Light only SW-ON
	Always OFF
	Warning

	Blinks ; Output suspended due to high temperature. Remove the battery from the tool and allow it to fully cool down.
	Blinks ; Output suspended due to failure or malfunction. The problem may be the battery so please contact your dealer.

## STANDARD ACCESSORIES

In addition to the main unit (1 unit), the package contains the accessories listed on page 20.

Standard accessories are subject to change without notice.

## APPLICATIONS

- Removal of casting fin and finishing of various types of steel, bronze and aluminum materials and castings.
- Grinding of welded sections or sections cut by means of a cutting torch.
- Grinding of synthetic resins, slate, brick, marble, etc.

## SPECIFICATIONS

### 1. Power tool

The specifications of this machine are listed in the Table on page 18.

### NOTE

Due to HiKOKI's continuing program of research and development, the specifications herein are subject to change without prior notice.

### Electronic control





- Soft start  
Reduces recoil against the operator by managing the number of rotations during startup.
- Kickback Protection  
The kickback protection feature cuts off the power to the motor and stops the power tool in the event of a sudden drop in the rotational speed of the wheel during operation (for example, if the wheel locks during cutting operation, etc.).
- Overload protection  
While working, if a load exceeding a certain level is applied, or if the grinding disc is stopped for a certain amount of time, the motor will be stopped to protect the tool and for safety.  
Turn off the switch once, then turn it on again to start up the tool.
- Rotation recovery control function  
While working, if the tool is pressed too forcefully against the surface and the motor stops, if you lift up the tool and lighten the load, rotation will resume.  
Depending on the grinding disc used and the working conditions, the rotation recovery control may be stopped by overload protection.

### CAUTION

When using ET36A, this function does not operate.

- Overheat protection  
This protection feature cuts off the power to the motor and stops the power tool in the event of overheating of motor during operation.  
When the overheat protection feature has been activated, the motor may stop.  
In this case, release the tool switch and cool it down in a few minutes.  
After that you can use it again.

### Battery

	Lights ; The battery remaining power is over 75%
	Lights ; The battery remaining power is 50%–75%.
	Lights ; The battery remaining power is 25%–50%.
	Lights ; The battery remaining power is less than 25%
	Blinks ; The battery remaining power is nearly empty. Recharge the battery soonest possible.

- Restart prevention function  
When the power is still switched on, the tool will not restart when a battery is installed. This function can be canceled once the tool is switched off.
- Brake function  
Brake activates when the switch is off.

**CAUTION**

- When using ET36A, this function does not operate.
- Drop shut off function <G3613DVE>  
When the drop shut off function has been activated, the motor may stop.  
In this case, release the tool switch.  
After that you can use it again.

2. Battery

Model	BSL36A18X
Voltage	36 V / 18 V (Automatic Switching*)
Battery capacity	2.5 Ah / 5.0 Ah (Automatic Switching*)

- \* The tool itself will automatically switch over.
- \*\* Please see our general catalogue for details.

**CHARGING**

Before using the power tool, charge the battery as follows.

1. **Connect the charger's power cord to the receptacle.**  
When connecting the plug of the charger to a receptacle, the charge indicator lamp will blink in red (At 1- second intervals).
2. **Insert the battery into the charger.**  
Firmly insert the battery into the charger as shown in Fig. 4 (on page 2).
3. **Charging**

When inserting a battery in the charger, the charge indicator lamp will blink in blue.  
When the battery becomes fully recharged, the charge indicator lamp will light up in green. (See **Table 1**)

- (1) Charge indicator lamp indication  
The indications of the charge indicator lamp will be as shown in **Table 1**, according to the condition of the charger or the rechargeable battery.

**Table 1**

Charger status	Status of indicator lamp	Indication meaning
Before charging	ON/OFF at 0.5 sec. intervals (RED) 	Plugged into power source *1
While charging	Lights for 0.5 sec. at intervals of 1 sec. (BLUE) 	Charged at less than 50%
	Lights for 1 sec. at intervals of 0.5 sec. (BLUE) 	Charged at less than 80%
	Lights continuously (BLUE) 	Charged at more than 80%
Charging complete	Lights continuously (GREEN)  (Continuous buzzer sound: about 6 sec.)	/
Overheat standby	ON/OFF at 0.3 sec. intervals (RED) 	Battery overheated. Unable to charge. *2
Charging impossible	ON/OFF at 0.1 sec. intervals (PURPLE)  (Intermittent buzzer sound: about 2 sec.)	Malfunction in the battery or the charger *3

\*1 If the red lamp continues to blink even after the charger has been attached, check to confirm that the battery has been fully inserted.

\*2 Although charging will start once the battery has cooled down even when left in situ, the best practice is to remove the battery and allow it to cool down in a shaded, well-ventilated location before charging.

\*3

- Fully insert the battery.
  - Check to confirm that no foreign matter is stuck to the battery mount or terminals.
- <If charging takes a long time>
- Charging will take longer at extremely low ambient temperatures. Charge the battery in a warm location (such as indoors).
  - Do not block the air vent. Otherwise the interior will overheat, reducing the charger's performance.
  - If the cooling fan is not operating, contact a HiKOKI Authorized Service Center for repairs.



- (2) Regarding the temperatures and charging time of the rechargeable battery  
The temperatures and charging time will become as shown in **Table 2**.

**Table 2**

Model		UC18YSL3		
Type of battery		Li-ion		
Charging voltage		14.4–18 V		
Temperatures at which the battery can be recharged		0°C–50°C		
Charging time, for battery capacity, approx. (At 20°C)	1.5 Ah	15 min		
	2.0 Ah	20 min		
	2.5 Ah	25 min		
	3.0 Ah	20 min (BSL1430C, BSL1830C: 30 min)		
	4.0 Ah	26 min (BSL1840M: 40 min)		
	5.0 Ah	32 min		
	6.0 Ah	38 min		
	8.0 Ah	52 min		
	Multi volt battery	1.5 Ah (x2 unit)	20 min	
		2.5 Ah (x2 unit)	32 min	
4.0 Ah (x2 unit)		52 min		
Number of battery cells		4–10		
Charging voltage for USB		5 V		
Charging current for USB		2 A		
Weight		0.6 kg		

**NOTE**

The recharging time may vary according to the ambient temperature and power source voltage.

4. **Disconnect the charger's power cord from the receptacle.**

5. **Hold the charger firmly and pull out the battery.**

**NOTE**

Be sure to pull out the battery from the charger after use, and then keep it.

**Regarding electric discharge in case of new batteries, etc.**

As the internal chemical substance of new batteries and batteries that have not been used for an extended period is not activated, the electric discharge might be low when using them the first and second time. This is a temporary phenomenon, and normal time required for recharging will be restored by recharging the batteries 2–3 times.

**How to make the batteries perform longer.**

- (1) Recharge the batteries before they become completely exhausted.

When you feel that the power of the tool becomes weaker, stop using the tool and recharge its battery. If you continue to use the tool and exhaust the electric current, the battery may be damaged and its life will become shorter.

- (2) Avoid recharging at high temperatures.

A rechargeable battery will be hot immediately after use. If such a battery is recharged immediately after use, its internal chemical substance will deteriorate, and the battery life will be shortened. Leave the battery and recharge it after it has cooled for a while.

**CAUTION**

- If the battery is charged while it is heated because it has been left for a long time in a location subject to direct sunlight or because the battery has just been used, the charge indicator lamp of the charger lights for 0.3 seconds, does not light for 0.3 seconds (off for 0.3 seconds). In such a case, first let the battery cool, then start charging.
- When the charge indicator lamp flickers (at 0.2-second intervals), check for and take out any foreign objects in the charger's battery connector. If there are no foreign objects, it is probable that the battery or charger is malfunctioning. Take it to your authorized Service Center.

**MOUNTING AND OPERATION**

Action	Figure	Page
Removing and inserting the battery	3	2
Charging	4	2
Attaching and removing the guard clip*1	5	2
Fitting and adjusting the wheel guard*2	6	3
Fixing the side handle	7	3
Assembling depressed center wheel*4	8	4
Assembling cutting wheel and diamond wheel*3, *4	9	4
Switch operation	10	4
Switching operation modes*5	11	4
Adjusting the number of revolution*5	12	5
Using the LED light*6	13	5
Grinding angle and grinding method*7	14	5
Cutting work*8	15	5
Remaining battery indicator	16	5
Charging a USB device from a electrical outlet	18-a	6
Charging a USB device and battery from a electrical outlet	18-b	6
How to recharge USB device	19	6
When charging of USB device is completed	20	6
Selecting accessories	—	21

\*1 Attaching and removing the guard clip  
Pull on the tabs while removing the guard clip.  
When attaching the guard clip, ensure that its tabs (2 locations) are hooked on the rim of the wheel guard.

\*2 Fitting and adjusting the wheel guard  
The wheel guard can be adjusted to an optimal angle for the work.  
Fix the wheel guard in place where its hole is aligned with the bump of the lever before use.

\*3 sold separately





#### 4. Maintenance of the motor

The motor unit winding is the very "heart" of the power tool. Exercise due care to ensure the winding does not become damaged and/or wet with oil or water.

#### NOTE

In order to expel debris and dust, periodically run the motor with no load.

#### 5. Inspection of terminals (tool and battery)

Check to make sure that swarf and dust have not collected on the terminals.

On occasion check prior, during and after operation.

#### CAUTION

Remove any swarf or dust which may have collected on the terminals.

Failure to do so may result in malfunction.

#### 6. Cleaning on the outside

When the cordless disc grinder is stained, wipe with a soft dry cloth or a cloth moistened with soapy water. Do not use chloric solvents, gasoline or paint thinner, for they melt plastics.

#### 7. Storage

Store the power tool and battery in a place in which the temperature is less than 40°C and out of reach of children.

#### NOTE

Storing lithium-ion batteries.

Make sure the lithium-ion batteries have been fully charged before storing them.

Prolonged storage (3 months or more) of batteries with a low charge may result in performance deterioration, significantly reducing battery usage time or rendering the batteries incapable of holding a charge.

However, significantly reduced battery usage time may be recovered by repeatedly charging and using the batteries two to five times.

If the battery usage time is extremely short despite repeated charging and use, consider the batteries dead and purchase new batteries.

#### CAUTION

In the operation and maintenance of power tools, the safety regulations and standards prescribed in each country must be observed.

#### **Important notice on the batteries for the HiKOKI cordless power tools**



Please always use one of our designated genuine batteries. We cannot guarantee the safety and performance of our cordless power tool when used with batteries other than these designated by us, or when the battery is disassembled and modified (such as disassembly and replacement of cells or other internal parts).



---



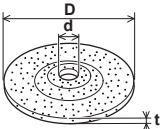

#### NOTE

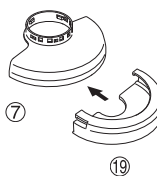
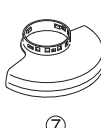

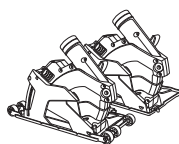
Due to HiKOKI's continuing program of research and development, the specifications herein are subject to change without prior notice.

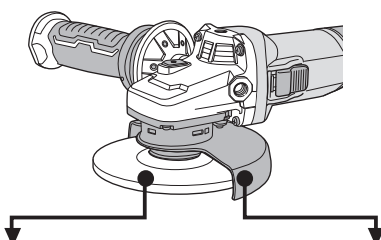
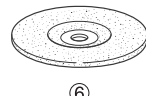
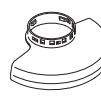
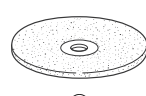
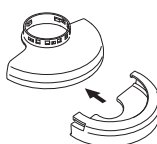
---

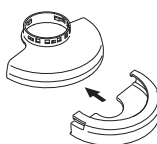
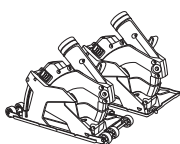
		G3613DVE G3613DVF
V		36
n		3200–10000 /min A: 5500 /min
	D	125 mm
	d	22.23 mm
	t	6 mm
		80 m/s
		3.2 kg (BSL36A18X) 3.4 kg (BSL36B18X)

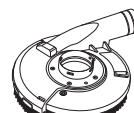
<p>Type A</p> 	<p>Type B</p> 	<p>Type E</p> 	<p>Type F</p> 
---	---	---	--

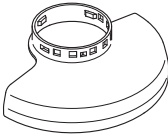
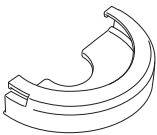
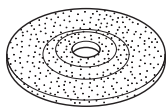
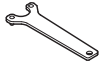
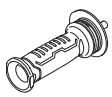
			
1		<p>Type B</p> 	
2		<p>Type A</p> 	
3		<p>Type A</p> 	<p>Type F</p> 
4		<p>Type E</p> 	

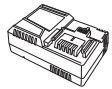
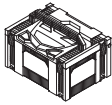
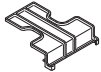
	G3613DVE / G3613DVF	
	(2XCZ)	(NN)
	1	1
	1	1
	1	1
	1	1
	1	1
 BSL36A18X	2	-
 UC18YSL3	1	-
	1	-
	2	-

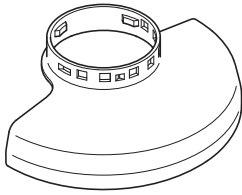

125 mm: 375904

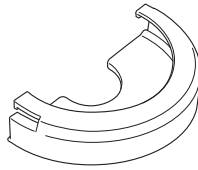

125 mm: 372701

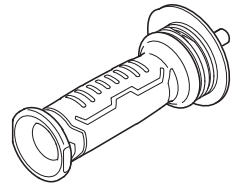

336865



371677

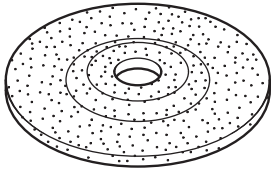

339579

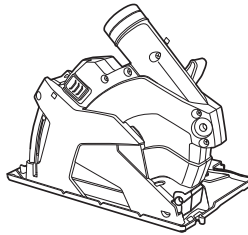

377085

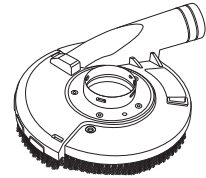

377087

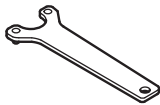

938332Z

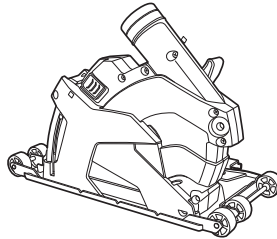

377086

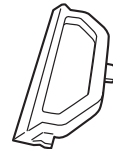

379591

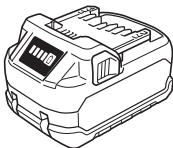

BSL36..18...

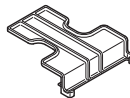

329897

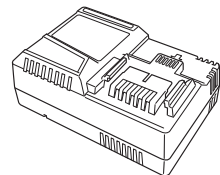

UC18YSL3  
(14.4 V-18 V)

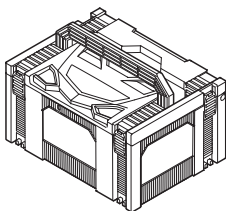

337108

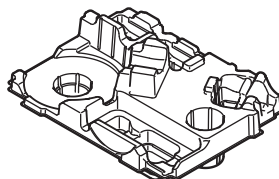

379422

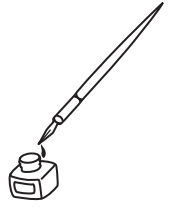



# Koki Holdings Co., Ltd.

Shinagawa Intercity Tower A, 15-1, Konan 2-chome,  
Minato-ku, Tokyo, Japan