

HIKOKI

G 13VE2

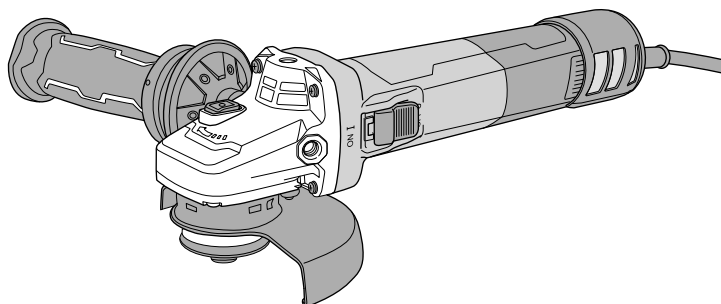

Handling instructions



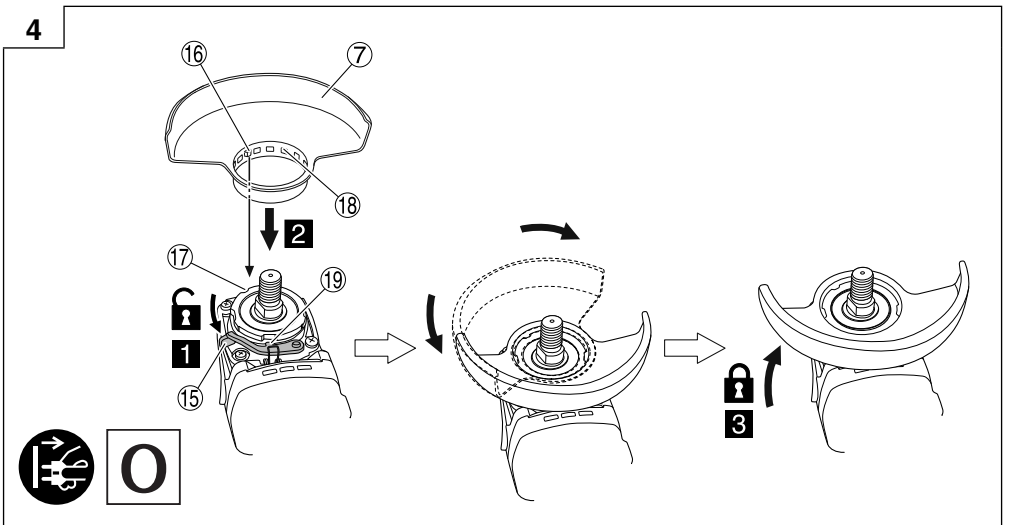
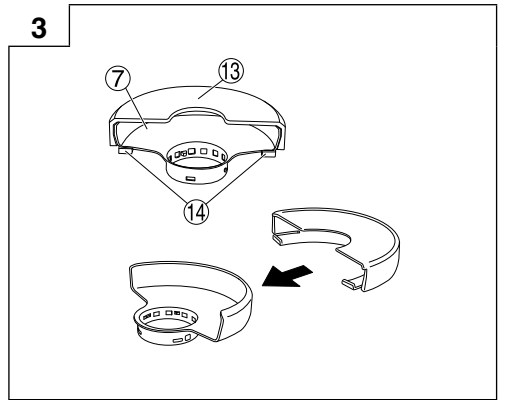
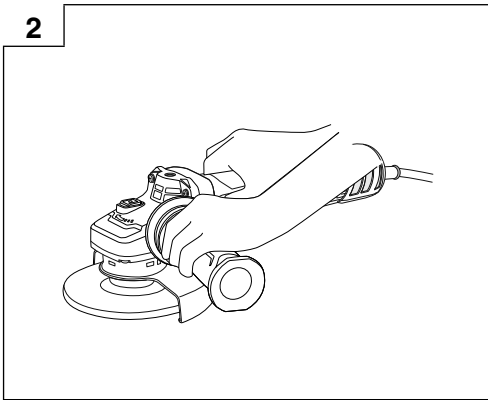
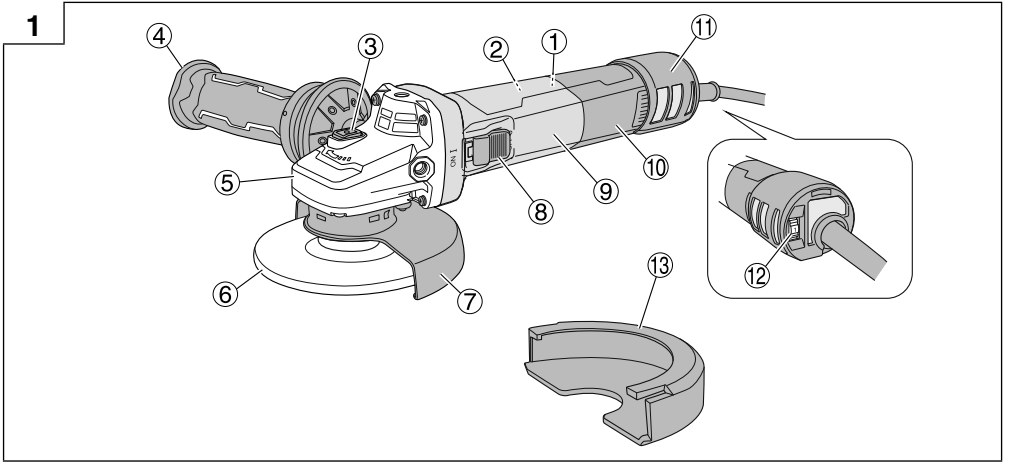

5

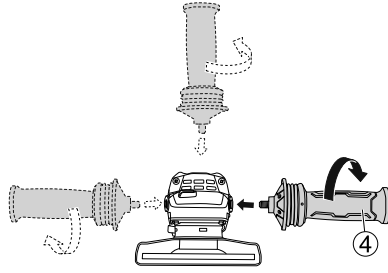

6

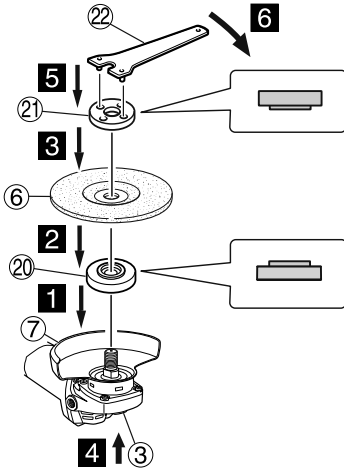

7

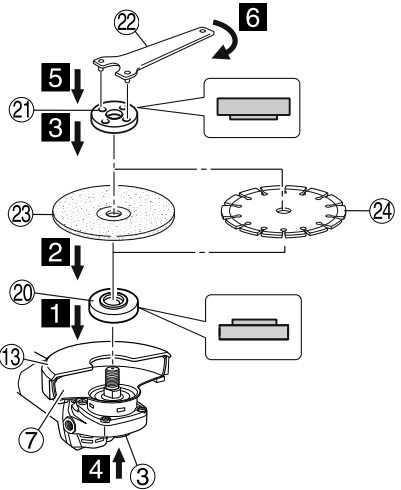

8

1 + 2 = I

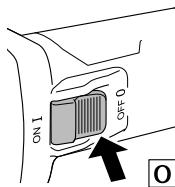
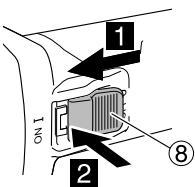

9

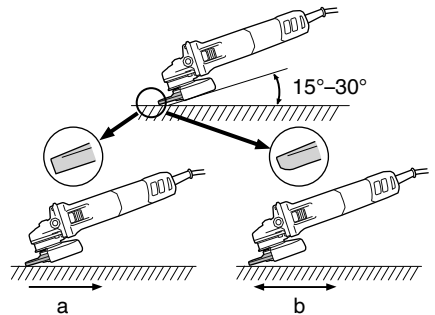

10

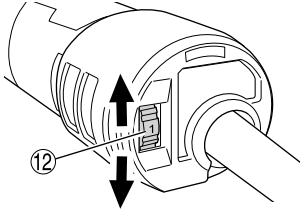

11

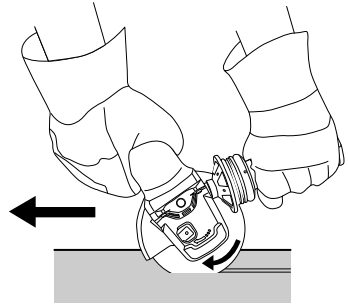

12

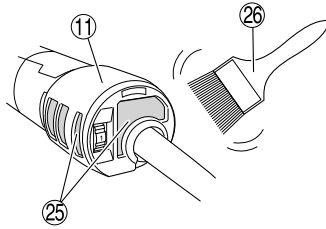

0

13

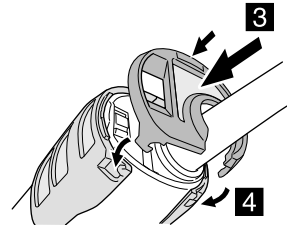
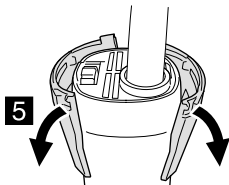
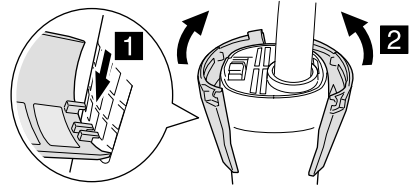
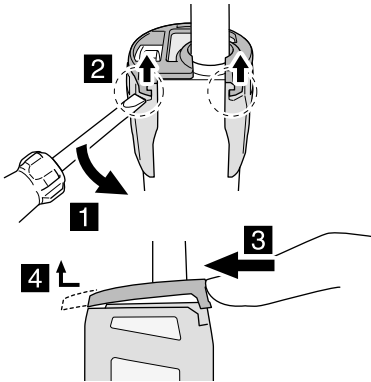

0

GENERAL POWER TOOL SAFETY WARNINGS

WARNING

Read all safety warnings, instructions, illustrations and specifications provided with this power tool.

Failure to follow all instructions listed below may result in electric shock, fire and/or serious injury.

Save all warnings and instructions for future reference.

The term "power tool" in the warnings refers to your mains-operated (corded) power tool or battery-operated (cordless) power tool.

1) Work area safety

- a) **Keep work area clean and well lit.**
Cluttered or dark areas invite accidents.
- b) **Do not operate power tools in explosive atmospheres, such as in the presence of flammable liquids, gases or dust.**
Power tools create sparks which may ignite the dust or fumes.
- c) **Keep children and bystanders away while operating a power tool.**
Distractions can cause you to lose control.

2) Electrical safety

- a) **Power tool plugs must match the outlet. Never modify the plug in any way. Do not use any adapter plugs with earthed (grounded) power tools.**
Unmodified plugs and matching outlets will reduce risk of electric shock.
- b) **Avoid body contact with earthed or grounded surfaces, such as pipes, radiators, ranges and refrigerators.**
There is an increased risk of electric shock if your body is earthed or grounded.
- c) **Do not expose power tools to rain or wet conditions.**
Water entering a power tool will increase the risk of electric shock.
- d) **Do not abuse the cord. Never use the cord for carrying, pulling or unplugging the power tool. Keep cord away from heat, oil, sharp edges or moving parts.**
Damaged or entangled cords increase the risk of electric shock.
- e) **When operating a power tool outdoors, use an extension cord suitable for outdoor use.**
Use of a cord suitable for outdoor use reduces the risk of electric shock.
- f) **If operating a power tool in a damp location is unavoidable, use a residual current device (RCD) protected supply.**
Use of an RCD reduces the risk of electric shock.

3) Personal safety

- a) **Stay alert, watch what you are doing and use common sense when operating a power tool. Do not use a power tool while you are tired or under the influence of drugs, alcohol or medication.**
A moment of inattention while operating power tools may result in serious personal injury.
- b) **Use personal protective equipment. Always wear eye protection.**
Protective equipment such as a dust mask, non-skid safety shoes, hard hat or hearing protection used for appropriate conditions will reduce personal injuries.

- c) **Prevent unintentional starting. Ensure the switch is in the off-position before connecting to power source and/or battery pack, picking up or carrying the tool.**

Carrying power tools with your finger on the switch or energising power tools that have the switch on invites accidents.

- d) **Remove any adjusting key or wrench before turning the power tool on.**
A wrench or a key left attached to a rotating part of the power tool may result in personal injury.
- e) **Do not overreach. Keep proper footing and balance at all times.**
This enables better control of the power tool in unexpected situations.
- f) **Dress properly. Do not wear loose clothing or jewellery. Keep your hair and clothing away from moving parts.**
Loose clothes, jewellery or long hair can be caught in moving parts.
- g) **If devices are provided for the connection of dust extraction and collection facilities, ensure these are connected and properly used.**
Use of dust collection can reduce dust-related hazards.
- h) **Do not let familiarity gained from frequent use of tools allow you to become complacent and ignore tool safety principles.**
A careless action can cause severe injury within a fraction of a second.

4) Power tool use and care

- a) **Do not force the power tool. Use the correct power tool for your application.**
The correct power tool will do the job better and safer at the rate for which it was designed.
- b) **Do not use the power tool if the switch does not turn it on and off.**
Any power tool that cannot be controlled with the switch is dangerous and must be repaired.
- c) **Disconnect the plug from the power source and/or remove the battery pack, if detachable, from the power tool before making any adjustments, changing accessories, or storing power tools.**
Such preventive safety measures reduce the risk of starting the power tool accidentally.
- d) **Store idle power tools out of the reach of children and do not allow persons unfamiliar with the power tool or these instructions to operate the power tool.**
Power tools are dangerous in the hands of untrained users.
- e) **Maintain power tools and accessories. Check for misalignment or binding of moving parts, breakage of parts and any other condition that may affect the power tool's operation. If damaged, have the power tool repaired before use.**
Many accidents are caused by poorly maintained power tools.
- f) **Keep cutting tools sharp and clean.**
Properly maintained cutting tools with sharp cutting edges are less likely to bind and are easier to control.
- g) **Use the power tool, accessories and tool bits etc. in accordance with these instructions, taking into account the working conditions and the work to be performed.**
Use of the power tool for operations different from those intended could result in a hazardous situation.
- h) **Keep handles and grasping surfaces dry, clean and free from oil and grease.**

Slippery handles and grasping surfaces do not allow for safe handling and control of the tool in unexpected situations.

5) Service

- a) **Have your power tool serviced by a qualified repair person using only identical replacement parts.**

This will ensure that the safety of the power tool is maintained.

PRECAUTION

Keep children and infirm persons away.

When not in use, tools should be stored out of reach of children and infirm persons.

SAFETY WARNINGS COMMON FOR GRINDING OR ABRASIVE CUTTING-OFF OPERATIONS

- a) **This power tool is intended to function as a grinder or cut-off tool. Read all safety warnings, instructions, illustrations and specifications provided with this power tool.**

Failure to follow all instructions listed below may result in electric shock, fire and/or serious injury.

- b) **Operations such as sanding, wire brushing, polishing or hole cutting are not recommended to be performed with this power tool.**

Operations for which the power tool was not designed may create a hazard and cause personal injury.

- c) **Do not convert this power tool to operate in a way which is not specifically designed and specified by the tool manufacturer.**

Such a conversion may result in a loss of control and cause serious personal injury.

- d) **Do not use accessories which are not specifically designed and specified by the tool manufacturer.**

Just because the accessory can be attached to your power tool, it does not ensure safe operation.

- e) **The rated speed of the accessory must be at least equal to the maximum speed marked on the power tool.**

Accessories running faster than their rated speed can break and fly apart.

- f) **The outside diameter and the thickness of your accessory must be within the capacity rating of your power tool.**

Incorrectly sized accessories cannot be adequately guarded or controlled.

- g) **The dimensions of the accessory mounting must fit the dimensions of the mounting hardware of the power tool.**

Accessories that do not match the mounting hardware of the power tool will run out of balance, vibrate excessively and may cause loss of control.

- h) **Do not use a damaged accessory. Before each use inspect the accessory such as abrasive wheels for chips and cracks, backing pad for cracks, tear or excess wear, wire brush for loose or cracked wires. If power tool or accessory is dropped, inspect for damage or install an undamaged accessory. After inspecting and installing an accessory, position yourself and bystanders away from the plane of the rotating accessory and run the power tool at maximum no-load speed for one minute.**

Damaged accessories will normally break apart during this test time.

- i) **Wear personal protective equipment. Depending on application, use face shield, safety goggles or safety glasses. As appropriate, wear dust mask, hearing protectors, gloves and workshop apron capable of stopping small abrasive or workpiece fragments.**

The eye protection must be capable of stopping flying debris generated by various operations. The dust mask or respirator must be capable of filtering particles generated by your operation. Prolonged exposure to high intensity noise may cause hearing loss.

- j) **Keep bystanders a safe distance away from work area. Anyone entering the work area must wear personal protective equipment.**

Fragments of workpiece or of a broken accessory may fly away and cause injury beyond immediate area of operation.

- k) **Hold the power tool by insulated gripping surfaces only, when performing an operation where the cutting accessory may contact hidden wiring or its own cord.**

Cutting accessory contacting a "live" wire may make exposed metal parts of the power tool "live" and could give the operator an electric shock.

- l) **Position the cord clear of the spinning accessory.**

If you lose control, the cord may be cut or snagged and your hand or arm may be pulled into the spinning accessory.

- m) **Never lay the power tool down until the accessory has come to a complete stop.**

The spinning accessory may grab the surface and pull the power tool out of your control.

- n) **Do not run the power tool while carrying it at your side.**

Accidental contact with the spinning accessory could snag your clothing, pulling the accessory into your body.

- o) **Regularly clean the power tool's air vents.**

The motor's fan will draw the dust inside the housing and excessive accumulation of powdered metal may cause electrical hazards.

- p) **Do not operate the power tool near flammable materials.**

Sparks could ignite these materials.

- q) **Do not use accessories that require liquid coolants.**

Using water or other liquid coolants may result in electrocution or shock.

KICKBACK AND RELATED WARNINGS

Kickback is a sudden reaction to a pinched or snagged rotating wheel, backing pad, brush or any other accessory. Pinching or snagging causes rapid stalling of the rotating accessory which in turn causes the uncontrolled power tool to be forced in the direction opposite of the accessory's rotation at the point of the binding.

For example, if an abrasive wheel is snagged or pinched by the workpiece, the edge of the wheel that is entering into the pinch point can dig into the surface of the material causing the wheel to climb out or kick out. The wheel may either jump toward or away from the operator, depending on direction of the wheel's movement at the point of pinching.

Abrasive wheels may also break under these conditions.

Kickback is the result of power tool misuse and/or incorrect operating procedures or conditions and can be avoided by taking proper precautions as given below.

ADDITIONAL SAFETY WARNINGS SPECIFIC FOR ABRASIVE CUTTING- OFF OPERATIONS

- a) **Maintain a firm grip with both hands on the power tool and position your body and arm to allow you to resist kickback forces.** Always use auxiliary handle, if provided, for maximum control over kickback or torque reaction during start-up.

The operator can control torque reactions or kickback forces, if proper precautions are taken.

- b) **Never place your hand near the rotating accessory.** Accessory may kickback over your hand.
- c) **Do not position your body in the area where power tool will move if kickback occurs.** Kickback will propel the tool in direction opposite to the wheel's movement at the point of snagging.
- d) **Use special care when working corners, sharp edges etc. Avoid bouncing and snagging the accessory.** Corners, sharp edges or bouncing have a tendency to snag the rotating accessory and cause loss of control or kickback.
- e) **Do not attach a saw chain woodcarving blade, segmented diamond wheel with a peripheral gap greater than 10 mm or toothed saw blade.** Such blades create frequent kickback and loss of control.

- a) **Do not "jam" the cut-off wheel or apply excessive pressure. Do not attempt to make an excessive depth of cut.**

Overstressing the wheel increases the loading and susceptibility to twisting or binding of the wheel in the cut and the possibility of kickback or wheel breakage.

- b) **Do not position your body in line with and behind the rotating wheel.** When the wheel, at the point of operation, is moving away from your body, the possible kickback may propel the spinning wheel and the power tool directly at you.
- c) **When the wheel is binding or when interrupting a cut for any reason, switch off the power tool and hold it motionless until the wheel comes to a complete stop. Never attempt to remove the cut-off wheel from the cut while the wheel is in motion otherwise kickback may occur.**

Investigate and take corrective action to eliminate the cause of wheel binding.

- d) **Do not restart the cutting operation in the workpiece. Let the wheel reach full speed and carefully re-enter the cut.**

The wheel may bind, walk up or kickback if the power tool is restarted in the workpiece.

- e) **Support panels or any oversized workpiece to minimize the risk of wheel pinching and kickback.**

Large workpieces tend to sag under their own weight. Supports must be placed under the workpiece near the line of cut and near the edge of the workpiece on both sides of the wheel.

- f) **Use extra caution making a "pocket cut" into existing walls or other blind areas.**

The protruding wheel may cut gas or water pipes, electrical wiring or objects that can cause kickback.

- g) **Do not attempt to do curved cutting.**

Overstressing the wheel increases the loading and susceptibility to twisting or binding of the wheel in the cut and the possibility of kickback or wheel breakage, which can lead to serious injury.

GENERAL SAFETY INSTRUCTIONS FOR GRINDERS

- a) **Use only wheel types that are specified for your power tool and the specific guard designed for the selected wheel.**

Wheels for which the power tool was not designed cannot be adequately guarded and are unsafe.

- b) **The grinding surface of centre depressed wheels must be mounted below the plane of the guard lip.** An improperly mounted wheel that projects through the plane of the guard lip cannot be adequately protected.
- c) **The guard must be securely attached to the power tool and positioned for maximum safety, so the least amount of wheel is exposed towards the operator.**

The guard helps to protect the operator from broken wheel fragments, accidental contact with wheel and sparks that could ignite clothing.

- d) **Wheels must be used only for specified applications. For example: do not grind with the side of cut-off wheel.**

Abrasive cut-off wheels are intended for peripheral grinding, side forces applied to these wheels may cause them to shatter.

- e) **Always use undamaged wheel flanges that are of correct size and shape for your selected wheel.**

Proper wheel flanges support the wheel thus reducing the possibility of wheel breakage. Flanges for cut-off wheels may be different from grinding wheel flanges.

- f) **Do not use worn down wheels from larger power tools.**

A wheel intended for larger power tool is not suitable for the higher speed of a smaller tool and may burst.

- g) **When using dual purpose wheels always use the correct guard for the application being performed. Failure to use the correct guard may not provide the desired level of guarding, which could lead to serious injury.**

- Attach the side handle firmly, hold the housing and the side handle with both hands, and support the tool body securely. (Fig. 2)
- Check that speed marked on the wheel is equal to or greater than the rated speed of the grinder;
- Ensure that the wheel dimensions are compatible with the grinder;
- Inspect the grinding wheel before use, do not use chipped, cracked or otherwise defective products;
- Ensure that mounted wheels and points are fitted in accordance with the manufacturer's instructions;
- Ensure that blotters are used when they are provided with the bonded abrasive product and when they are required;
- Ensure that the abrasive product is correctly mounted and tightened before use and run the tool at no-load for 30 seconds in a safe position, stop immediately if there is considerable vibration or if other defects are detected. If this condition occurs, check the machine to determine the cause;
- If a guard is equipped with the tool never use the tool without such a guard;

- Do not use separate reducing bushings or adapters to adapt large hole abrasive wheels;
 - For tools intended to be fitted with threaded hole wheel, ensure that the thread in the wheel is long enough to accept the spindle length;
 - Do not use cutting off wheel for side grinding;
 - Ensure that sparks resulting from use do not create a hazard e.g. do not hit persons, or ignite flammable substances;
 - Ensure that ventilation openings are kept clear when working in dusty conditions, if it should become necessary to clear dust, first disconnect the tool from the mains supply (use non metallic objects) and avoid damaging internal parts;
 - Always use eye and ear protection. Other personal protective equipment such as dust mask, gloves, helmet and apron should be worn;
 - Pay attention to the wheel that continues to rotate after the tool is switched off.
 - When using dual-purpose (combined grinding and cut-off wheels), use only the type A wheel guard (See page 12)
 - When using a type A wheel guard for lateral grinding, the guard may interfere with the workpiece causing poor control.
 - When using a type B wheel guard for cutting-off operations with bonded cut-off wheels, there is an increased risk of exposure to emitted sparks and particles, as well as exposure to wheel fragments in the event of a wheel burst.
 - When using a type A, B wheel guard for cutting-off operations or lateral grinding in concrete or masonry, there is an increased risk of exposure to dust and loss of control resulting in kickback.
 - Do not use any segmented diamond cut-off wheels with segment slits >10 mm. Only negative segment cutting angles are permitted.
 - The workpiece must lay flat and be secured against slipping, e.g. using clamps. Large workpieces must be sufficiently supported.
 - Observe the specifications of the tool or accessory manufacturer. Protect wheels from grease or impact.
 - Accessories must be stored and handled with care in accordance with the manufacturer's instructions.
5. Confirm that the push button is disengaged by pushing push button two or three times before switching the power tool on.
 6. To prolong the life of the machine and ensure a first class finish, it is important that the machine should not be overloaded by applying too much pressure. In most applications, the weight of the machine alone is sufficient for effective grinding. Too much pressure will result in reduced rotational speed, inferior surface finish, and overloading which could reduce the life of the machine.
 7. The wheel continues to rotate after the tool is switched off.
After switching off the machine, do not put it down until the depressed center wheel has come to a complete stop. Apart from avoiding serious accidents, this precaution will reduce the amount of dust and swarf sucked into the machine.
 8. When the machine is not use, the power source should be disconnected.
 9. Be sure to switch OFF and disconnect the attachment plug from the receptacle to avoid a serious accident before the depressed center wheel is assembling and disassembling.
 10. When using the tool at any value except the full speed (Dial scale 6), the motor cannot be sufficiently cooled due to the decreased number of revolution. This could result in the risk of burning and damaging the motor before an overload protective mechanism starts to function.
Make sure that you use the tool by lightly applying it to the surface of material when you use it at any value except the full speed (Dial scale 6).
 11. Caution when using near welding equipment
When using the grinder in the immediate vicinity of welding equipment, the rotational speed may become unstable. Do not use the grinder near welding equipment.
 12. RCD
The use of a residual current device with a rated residual current of 30 mA or less at all times is recommended.
 13. Do not operate from a direct current power source, booster or any other type of transformer. Doing so may not only cause damage to the grinder, but may lead to accidents.
 14. Some mobile generators may not be usable with the machine.

WARNING

- When using a cutting-off wheel, be sure to attach a type A wheel guard.
- When using a grinding wheel, be sure to attach a type B wheel guard.
- For safety reasons, only use the wheel guard provided for the respective accessory. Using an incorrect wheel guard can lead to loss of control and serious injuries. See also page 12.

ADDITIONAL SAFETY WARNINGS

1. Ensure that the power source to be utilized conforms to the power requirements specified on the product nameplate.
2. Ensure that the power switch is in the OFF position. If the plug is connected to a receptacle while the power switch is in the ON position, the power tool will start operating immediately, which could cause a serious accident.
3. When the work area is removed from the power source, use an extension cord of sufficient thickness and rated capacity. The extension cord should be kept as short as practicable.
4. Ensure that the depressed center wheel to be utilized is the correct type and free of cracks or surface defects. Also ensure that the depressed center wheel is properly mounted and the wheel nut is securely tightened.

NAMES OF PARTS (Fig. 1–Fig. 13, Page 12)













①	Motor	⑪	Filter
②	Nameplate	⑫	Dial
③	Push button	⑬	Guard clip (mounted on wheel guard when packaged)
④	Side handle	⑭	Tabs of guard clip (2 locations)
⑤	Gear cover	⑮	Lever
⑥	Depressed center wheel (sold separately)	⑯	Bump of wheel guard
⑦	Toolless wheel guard	⑰	Notch of body
⑧	Switch	⑱	Hole of wheel guard
⑨	Housing	⑲	Bump of lever
⑩	Tail cover	⑳	Wheel washer

21	Wheel nut	26	Soft brush
22	Wrench	27	Diamond cup wheel (sold separately)
23	Abrasive cutting wheel (sold separately)	28	Dust collection adapter (For diamond cup wheel) (sold separately)
24	Diamond wheel (sold separately)	29	Dust collection adapter (For diamond wheel) (sold separately)
25	Mesh		

SYMBOLS

WARNING

The following show symbols used for the machine. Be sure that you understand their meaning before use.

	G13VE2: Disc Grinder
	To reduce the risk of injury, user must read instruction manual.
	Always wear eye protection.
	Always operate the power tool with two hands
	Not for cut-off operations When using a cutting-off wheel, be sure to attach the Type A wheel guard. When using a type B wheel guard for cutting-off operations with bonded cut-off wheels, there is an increased risk of exposure to emitted sparks and particles, as well as exposure to wheel fragments in the event of a wheel burst.
V	Rated voltage
~	Alternating current
n	Rated speed
/min	Revolution or reciprocations per minute
	Switching ON
	Switching OFF
	Lock
	Unlock
	Disconnect mains plug from electrical outlet
	Warning
	Class II tool

STANDARD ACCESSORIES

In addition to the main unit (1 unit), the package contains the accessories listed in the below.

- Wheel guard1
- Guard clip1
- Side handle1
- Wrench1

Standard accessories are subject to change without notice.

APPLICATIONS

- Removal of casting fin and finishing of various types of steel, bronze and aluminum materials and castings.
- Grinding of welded sections or sections cut by means of a cutting torch.
- Grinding of synthetic resins, slate, brick, marble, etc.
- Cutting of synthetic concrete, stone, brick, marble, and similar materials.

SPECIFICATIONS

Model	G13VE2	
Voltage	(230 V, 240 V) ~	
Power Input	1320 W	
Rated speed	2500–8500 /min	
Wheel	Outer dia.	125 mm
	Hole Dia.	22.23 mm
	Thickness	6 mm
Peripheral speed	80 m/s	
Weight*1	2.4 kg	

*1 Including wheel guard, wheel washer, wheel nut, and handle; without cord

Electronic control

- Soft start
Reduces recoil against the operator by managing the number of rotations during startup.
- 0 Voltage Re-start Protection
The 0 voltage restart protection feature prevents the power tool from restarting after the power has been temporarily cut off during operation.
- Constant speed
- Overload protection
This protection feature cuts off the power to the motor in the event of overloading of motor or a conspicuous reduction in rotational speed during operation.
When the overload protection feature has been activated, the motor may stop.
In this case, release the tool switch and eliminate causes of overloading.
After that you can use it again.
- Rotation recovery control function
When the motor is stopped due to overloading, if the cause is eliminated, the motor automatically resumes operation.
During grinding, if the motor stops due to pressing too forcefully with the grinder, gently lift the tool body to start rotation again.
When the motor is stopped for a certain period of time, it does not recover, for the protection of the unit and for safety.
Turn it off once and on again to start it.

- Overheat protection
This protection feature cuts off the power to the motor and stops the power tool in the event of overheating of motor during operation.
When the overheat protection feature has been activated, the motor may stop.
In this case, release the tool switch and cool it down in a few minutes.
After that you can use it again.

NOTE

- To prevent the tip tool from falling off, the brake will not be applied when the switch is released right after startup (within one second).
- Due to HIKOKI's continuing program of research and development, the specifications herein are subject to change without prior notice.

MOUNTING AND OPERATION

Action	Figure	Page
Attaching and removing the guard clip*1	3	2
Fitting and adjusting the wheel guard*2	4	2
Fixing the side handle	5	3
Assembling depressed center wheel*3 *4	6	3
Assembling cutting wheel and diamond wheel*3 *4	7	3
Switch operation*5	8	3
Grinding angle and grinding method*6	9	3
Adjusting the number of the revolution*7	10	4
Cutting work*8	11	4
Selecting accessories	—	13

*1 Attaching and removing the guard clip
Pull on the tabs while removing the guard clip.
When attaching the guard clip, ensure that its tabs (2 locations) are hooked on the rim of the wheel guard.

*2 Fitting and adjusting the wheel guard
The wheel guard can be adjusted to an optimal angle for the work.
Fix the wheel guard in place where its hole is aligned with the bump of the lever before use.

*3 Sold separately

*4 WARNING

Before use, be sure to tighten the wheel nut with the included wrench.

Failure to tighten could result in the wheel nut loosening when the brake is activated during a stop.

NOTE

The wheel washer is specifically for this product. Do not use it for any other product.

*5 When the 0 voltage re-start protection feature has been activated, return the power switch to the OFF position and wait for 1 second or more before restarting the power tool.

*6 Grinding angle and grinding method
Press down the machine evenly on the surface and move back and forth so that the surface of the workpiece does not become too hot.

Rough grinding: position the machine at an angle of 15°–30° for the best working results.

When the grinding stone is new, its corner may dig in when it is pushed forward, so pull back as shown in "a" during use.

Once the wheel edge is worn, the workpiece can be ground in both directions.

- *7 Adjusting the number of revolution
This model is equipped with an electronic infinite-variable-speed drive and can change the number of revolution according to a use.
If you turn and set the dial scale to 6, the number of revolution increases, and if you turn and set it to 1, the number of revolution decreases.
Before use, set the number of revolution using the dial. In so doing, refer to the following table as a rough guide.

Dial	Use	Tools
1	Polishing, finishing	Radial grinding disc Sanding disc
2	Removal of paint or coat	
3	Removal of rust	
4	Removal of burrs	
5	Grinding	Depressed center wheel
6	Rough grinding Cutting	Depressed center wheel Diamond wheel

NOTE

Use caution not to turn the dial scale to any value below 1 or above 6.

*8 Cutting work

Always work against the run of the disc. Otherwise there is the danger of the machine kicking back from the cut out of control. Guide the machine evenly at a speed suitable for the material being processed. Do not tilt, apply excessive force or sway from side to side.

MAINTENANCE AND INSPECTION

WARNING

- Be sure to switch power OFF and disconnect the plug from the receptacle during maintenance and inspection.
- Using cracked, deformed or damaged wheels can lead to wheel breakage and resulting serious injury.

1. Inspecting the depressed center wheel

Ensure that the depressed center wheel is free of cracks and surface defects.

2. Inspecting the mounting screws

Regularly inspect all mounting screws and ensure that they are properly tightened. Should any of the screws be loose, retighten them immediately. Failure to do so could result in serious hazard.

3. Replacing supply cord

If the replacement of the supply cord is necessary, it has to be done by HiKOKI Authorized Service Center to avoid a safety hazard.

4. Filter cleaning and inspection

WARNING

Wear protective glasses and a dust mask when cleaning the filter with an air gun.

Failure to do so may result in inhalation or exposure of the eyes to debris or dust.

After use, remove any debris or dust adhered to the filter using a soft brush. (Fig. 12) Check the filter periodically to ensure that it is free of scratching, chipping, or tearing. Replace with a new filter if the filter is damaged in any way.

NOTE

If the mesh is clogged and the debris or dust cannot be removed, detach the filter and clean it with an air gun, etc. (See "Exchanging the filter set (Fig. 13)")

5. Exchanging the filter set (Fig. 13)

NOTE

- When detaching the filter, be careful not to let debris enter the tool body.
- Leave the filter set attached to the body, except when cleaning or exchanging the filter set.

6. Maintenance of the motor

The motor unit winding is the very "heart" of the power tool. Exercise due care to ensure the winding does not become damaged and/or wet with oil or water.

NOTE

In order to expel debris and dust, periodically run the motor with no load.

7. Cleaning on the outside

When the power tool is stained, wipe with a soft dry cloth or a cloth moistened with soapy water. Do not use chloric solvents, gasoline or paint thinner, for they melt plastics.

8. Storage



Store the power tool in a place in which the temperature is less than 40°C and out of reach of children.





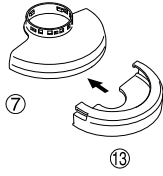

CAUTION

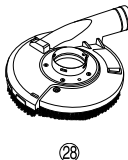
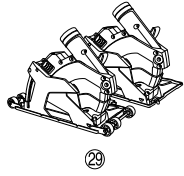
In the operation and maintenance of power tools, the safety regulations and standards prescribed in each country must be observed.

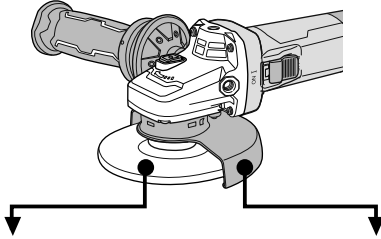
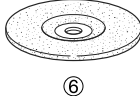
NOTE

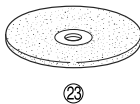
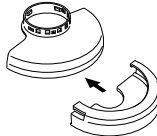
Due to HiKOKI's continuing program of research and development, the specifications herein are subject to change without prior notice.

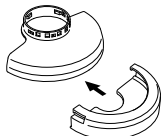
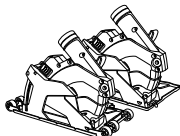
<p>Type A</p> 	<p>Type B</p> 	<p>Type E</p> 	<p>Type F</p> 
---	---	---	--

			
1		<p>Type B</p> <p>7</p> 	
2		<p>Type A</p> <p>7 + 13</p> 	
3		<p>Type A</p> <p>7 + 13</p>  <p style="margin-left: 200px;">Type F</p> <p>29</p> 	
4		<p>Type E</p> <p>28</p> 	

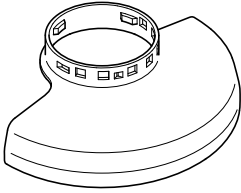

375907

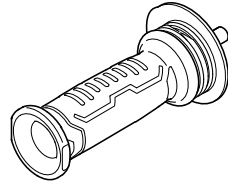

336865

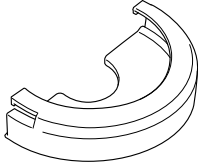

372701

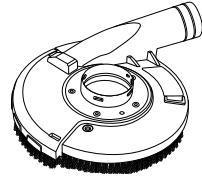

377087



310338

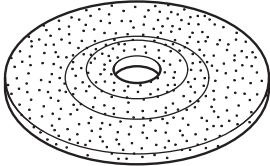

339579

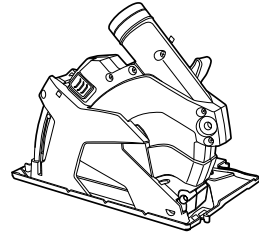

377085

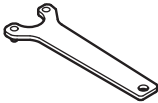

938332Z

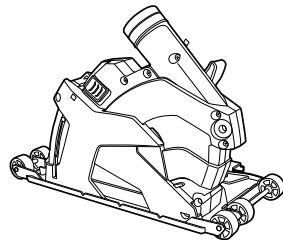

377086

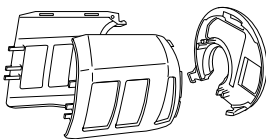

379204

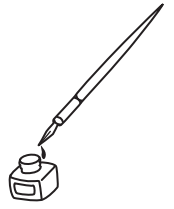

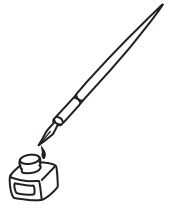

Koki Holdings Co., Ltd.

Shinagawa Intercity Tower A, 15-1, Konan 2-chome,
Minato-ku, Tokyo, Japan