

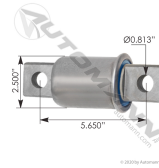

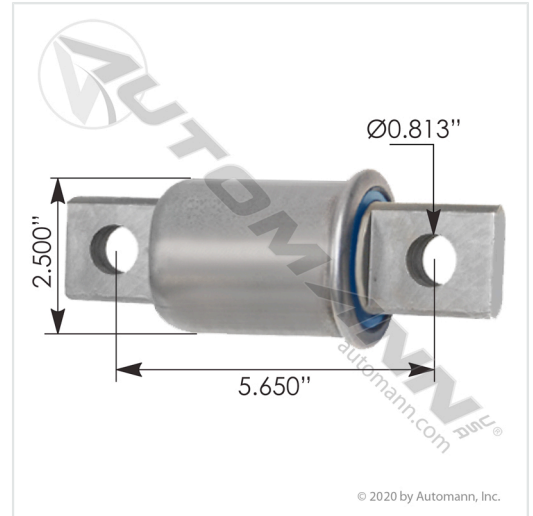

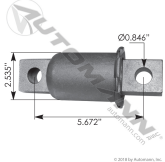

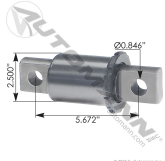
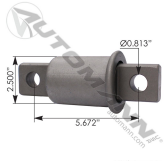

Silent Block Poly Premium Freightlr/IHC

Automann #	MR782E
UPC Code	889626175022
Categories	Poly & Rubber > Ford > Poly Bushings Poly & Rubber > Freightliner > Poly Bushings Poly & Rubber > International > Poly Bushings Poly & Rubber > Peterbilt > Poly Bushings Suspension > Ford > Bushings-Silent Block Suspension > Freightliner > Bushings-Silent Block Suspension > International > Bushings-Silent Block Suspension > Peterbilt > Bushings-Silent Block Browse by Make/Model > Freightliner > Cascadia P3 (2008-2018) > Suspension Browse by Make/Model > International > ProStar > Suspension/Steering Browse by Make/Model > Kenworth > T660 > Suspension Browse by Make/Model > Peterbilt > 379 > Suspension Browse By Brand > Automann Browse by Make/Model > Kenworth > T680 Next Gen > Suspension Browse by Make/Model > Peterbilt > 579 2022 > Suspension
Brand	Automann
Product Level	Fleet Premium Heavy Duty
Description	<ul style="list-style-type: none"> • Poly, Fully Rotational • IROS Corporate Air Ride • For Oversized Use MR783E
Ref. #	Poly Version of MR782
Applications	Freightliner, International, Kenworth, Peterbilt
Shipping	Parcel friendly
Unit Size	1
Weight	4.68 lbs
Pkg. Dims (in)	8.25 X 3.5 X 3.562
Pkg. Dims (in)	

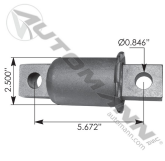
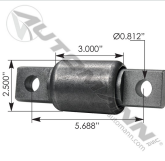

Related Items

Automann #	Image	Product Name
MR781		Silent Block
MR656UB		Silent Block Poly
MR779UB		Silent Block Poly Freightliner
MR782		Silent Block Freightliner/IHC
MR714E		Discontinued Use MR782E
MR779		Silent Block
MR656		Silent Block Freightliner
MR714UB		Silent Block Freightliner
MR714		Silent Block Freightliner

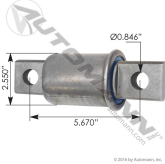
Automann #	Image	Product Name
579.OT4245		Suspension Bushing Kit FAS II OTC
MR783		Oversized Version of MR782
MR783E		Silent Block OS Poly Premium Freightlr

Specifications

Attribute	Value
Applications	Freightliner International Kenworth Peterbilt
Bushing (Type 1)	Premium Poly Bushing
Bushing (Type 2)	Straddlemount
Sleeve Type	High Confinment
SRI	RB268
Bushing OD (B)	2.500"
Overall Length (C)	7.500"
Bushing Sleeve Length (D)	3.250"
Bolt ID	13/16"
Center to Center	5.672"
OEM Ref.	16005092
Notes	Type 5

Alternative Items

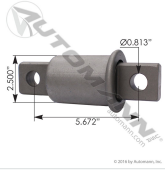
Automann #	Image	Product Name	Brand	Product Level
MR782		Silent Block Freightliner/IHC	Automann	Fleet Standard

Where Used

This item is featured in the following schematics:

Name	Type
Freightliner Rear Fas Airliner II (Freightliner & Sterling)	Suspension
International Navistar Rear New Corporate Air IROS '02-'10	Suspension
Peterbilt Rear New Low Air Leaf® (Kenworth AG210L, AG400L)	Suspension

Series

Make	Series	Additional Information
Freightliner	Cascadia (No Year)	
International	ProStar (No Year)	
Kenworth	T660 (No Year)	
Peterbilt	379 (No Year)	

Cross Reference

There is no cross reference data for this product.