

# Pogo Stick Chrome Finish 40 in.

Chrome-Finish Pogo Stick, 40 in., for Hose and Cable Management

Automann #	177.3003
UPC Code	889626036798
Categories	<a href="#">Browse by Make/Model &gt; Trucks &gt; Kenworth &gt; T660 &gt; Miscellaneous</a> <a href="#">Browse by Make/Model &gt; Trucks &gt; Volvo/White &gt; VNL 670 Gen 2 [2004-2018] &gt; Miscellaneous</a> <a href="#">Browse by Make/Model &gt; Trucks &gt; Peterbilt &gt; 379 &gt; Accessories</a> <a href="#">Browse By Brand &gt; Automann</a> <a href="#">Air Brake &amp; Wheel &gt; Air &amp; Electrical Connectors &amp; Assemblies &gt; Hose &amp; Cable Suspension Equipment &gt; Pogo Sticks &amp; Accessories &gt; Pogo Sticks</a>
Brand	Automann
Product Level	Fleet Standard
Description	<ul style="list-style-type: none"> <li>• Chrome Finish, 40 in. Length</li> <li>• Steel body, Gray color</li> <li>• Enclosed spring design</li> <li>• Single mounting hole</li> </ul>
Ref. #	9400G, 581103, 34200
Applications	Universal
Shipping	<b>Parcel Friendly</b>
Unit Size	1
Weight	4.5 lbs
Pkg. Dims (in)	42.75 X 3.035 X 2.835
Pkg. Dims (in)	
Arrival Date	July 2010

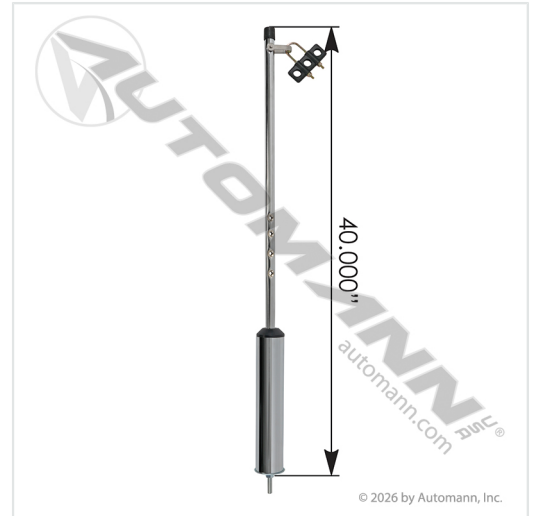

## Product Overview

Automann's pogo stick manages and secures air lines and electrical cables running between the tractor and trailer. Chrome-finish steel construction with an enclosed spring holds cables clear of the ground and deck plate, preventing dragging, tangling, and premature wear during transport. Mounts behind the cab with a single fastener.



## Specific Features & Benefits

- 40 in. Steel body provides sufficient reach for standard tractor-trailer hose and cable configurations
- Enclosed Spring design protects the spring from road debris and contamination
- Single Mounting Hole enables fast installation to the frame behind the cab with minimal hardware
- Secures Air Brake and Electrical Lines to prevent dragging or kinking during transport









## Specifications



Attribute	Value
Applications	Universal
Overall Length	40"
Finish	Chrome
Number of Mounting Studs	1
Body Material	Steel

## Alternative Items

Automann #	Image	Product Name	Brand	Product Level
<a href="#">177.3001</a>		Pogo Stick Stainless Steel Finish 40in	Automann	Fleet Standard
<a href="#">177.3002</a>		Pogo Stick Zinc Dichromate Finished 40in	Automann	Fleet Standard
<a href="#">PHI17-0400</a>		Pogo Stick - Bright Chrome 40in	Phillips	OE

## Related Items

Automann #	Image	Product Name	Brand	Product Level
177.6068		Light Plug and Gladhand Holder 4-Way	Automann	Fleet Standard
PHI11-315		Air Coil Set 15ft HD	Phillips	OE
177.6009		Double Coupler and Plug Holder	Automann	Fleet Standard
177.3024		Pogo Stick Zinc Dichromate 24in	Automann	Fleet Standard
177.3026		Pogo Stick Chrome 24in	Automann	Fleet Standard
177.6044		Light Plug and Gladhand Holder 3-Way	Automann	Fleet Standard
PHI17-153		Hose Holder - QWIK-SNAP 3-Hose w/ Clip	Phillips	OE
PHI30-4621		ABS Cable PERMACOIL 15ft	Phillips	OE
177.6007		Single Coupler & Plug Holder	Automann	Fleet Standard

Automann #	Image	Product Name	Brand	Product Level
177.3022		Pogo Stick Stainless Steel 24in	Automann	Fleet Standard
177.3025		Pogo Stick Zinc Dichromate 50in	Automann	Fleet Standard
177.3027		Pogo Stick Chrome 50in	Automann	Fleet Standard

## Where Used

There is no usage data for this product.

## Series

Make	Series	Additional Information
Kenworth	T660 (No Year)	
Peterbilt	379 (No Year)	
Volvo/White	VNL 670 Gen 2 (2003-2019) (No Year)	
Kenworth	T660 (Unspecified.)	
Peterbilt	379 (Unspecified.)	
Volvo/White	VNL 670 Gen 2 (2003)	
Volvo/White	VNL 670 Gen 2 (2004)	
Volvo/White	VNL 670 Gen 2 (2005)	
Volvo/White	VNL 670 Gen 2 (2006)	
Volvo/White	VNL 670 Gen 2 (2007)	
Volvo/White	VNL 670 Gen 2 (2008)	
Volvo/White	VNL 670 Gen 2 (2009)	
Volvo/White	VNL 670 Gen 2 (2010)	
Volvo/White	VNL 670 Gen 2 (2011)	

Make	Series	Additional Information
Volvo/White	VNL 670 Gen 2 (2012)	
Volvo/White	VNL 670 Gen 2 (2013)	
Volvo/White	VNL 670 Gen 2 (2014)	
Volvo/White	VNL 670 Gen 2 (2015)	
Volvo/White	VNL 670 Gen 2 (2016)	
Volvo/White	VNL 670 Gen 2 (2017)	
Volvo/White	VNL 670 Gen 2 (2018)	
Volvo/White	VNL 670 Gen 2 (2019)	

## Cross Reference

Name	Part Number	Notes
Midland	11512	Pogo Stick Chrome
Phillips	170400	Pogo Stick Chrome
Tectran	9400G	Pogo Stick Chrome
Tectran	9400G2	Pogo Stick Chrome