

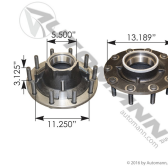

Outboard Mount Hub Assembly

Automann #	150.T1104.S2
UPC Code	889626346736
Categories	Browse By Brand > Automann Air Brake & Wheel > Hubs > Trailer Axle > Hub Assemblies > Hub-Piloted (FN) > Outboard Drum Mount - Dual Steel Wheels
Brand	Automann
Product Level	Fleet Standard
Description	
Ref. #	203313T
Shipping	Parcel shipment surcharge
Unit Size	1
Weight	54.24 lbs

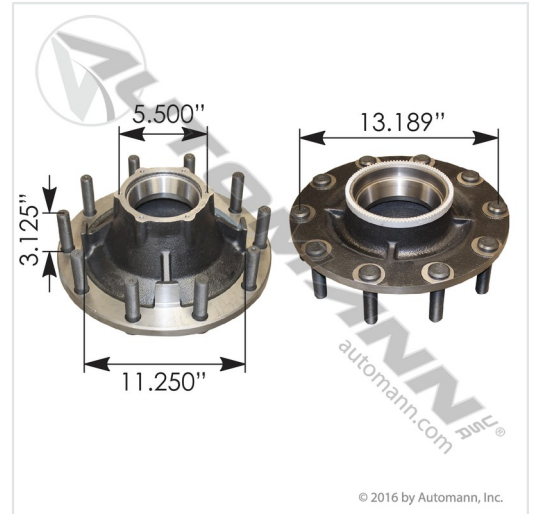
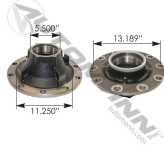

Related Items

Automann #	Image	Product Name
150.T1104		Outboard Mount Hub
150.T1104.S1		Outboard Mount Hub Assembly
150.T1104.A1		Hub-Drum Assembly



Automann #	Image	Product Name
151.6723		Brake Drum 16.500in X 7.000in

Specifications

Attribute	Value
Hubs By	Trailer Axle
Includes Inner Race	182.HM218210
Includes Outer Race	182.HM212011
Drum Mounting	Outboard
ABS	Yes, 150.ABS1554
Body Type	Cast
Overall Height	7.210
Distance Between Cups	3.340
Bolt Circle Dia.	13.189
Bolt Holes	10
Includes Wheel Studs	201.6151
Recommended Wheel Studs	Included
Hubcap Holes	6 @ 5/16-18
Hubcap Bolt Circle Dia.	5.500"

Includes

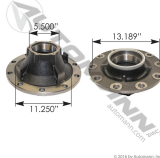
Automann #	Image	Product Name	QTY
182.HM218210		Wheel Bearing Cup	1
182.HM212011		Wheel Bearing Cup	1

Automann #	Image	Product Name	QTY
150.ABS1554	 100 Tooth O.D.: 7.062" Inside Mounting Diameter: 6.500"	ABS Tone Ring for Wheel Hub	1
150.T1104	 5.600" 13.189" 11.250"	Outboard Mount Hub	1
201.6151	 A = 0.750" B = 0.375" 3.000" BODY DIA. 0.975" M22 X 1.5 3.938"	Wheel Stud	10

Where Used

There is no usage data for this product.

Series

There is no series data for this product.

Cross Reference

Name	Part Number	Notes
Webb	203313T	Outboard Mount Hub Assembly
Automann Old #	150.2033.S2	Outboard Mount Hub Assembly